



NOTICE AND CALL OF A SPECIAL MEETING
OF THE
ADMINISTRATIVE BOARD OF APPEALS

NOTICE IS HEREBY GIVEN that a Special Meeting of the Garden Grove Administrative Board of Appeals is hereby called to be held on Wednesday, March 27, 2024 at 6:00 p.m. in the Garden Grove Community Meeting Center, 11300 Stanford Avenue.

Said Special Meeting shall be held to discuss the attached Agenda.

Dated: March 20, 2024

David Dent
Deputy Director of Community Development
Chief Building Official
Executive Secretary to the Board



AGENDA

ADMINISTRATIVE BOARD OF APPEALS (ABOA)

SPECIAL MEETING
COMMUNITY MEETING CENTER
11300 STANFORD AVENUE
MARCH 27, 2024 - 6:00 P.M.

Meeting Assistance: Any person requiring auxiliary aids and services, due to a disability, to address the Administrative Board of Appeals, should contact the City Clerk's office at (714) 741-5040 72 hours prior to the meeting to arrange for special accommodations. (Government Code §5494.3.2).

Agenda Item Descriptions: Are intended to give a brief, general description of the item. The Administrative Board of Appeals may take legislative action deemed appropriate with respect to the item and is not limited to the recommended action indicated in staff reports or the agenda.

Documents/Writings: Any revised or additional documents/writings related to an item on the agenda distributed to all or a majority of the Administrative Board of Appeals within 72 hours of a meeting, are made available for public inspection at the same time (1) in the Building and Safety Division at 11222 Acacia Parkway, Garden Grove, CA 92840, during normal business hours; and (1) at the Community Meeting Center at the time of the meeting.

Public Comments: Members of the public who attend the meeting in-person and would like to address the Administrative Board of Appeals are requested to complete a yellow speaker card indicating their name and address, and identifying the subject matter they wish to address. This card should be given to the Recording Secretary before the meeting begins. General comments are made during "Oral Communications" and are limited to three (3) minutes and to matters the Administrative Board of Appeals has jurisdiction over. Members of the public who wish to comment on matters before the Board, in lieu of doing so in person, may submit comments by emailing building@ggcity.org no later than 3:00 p.m. the day of the meeting. The comments will be provided to the Board as part of the meeting record.

PLEASE SILENCE YOUR CELL PHONES DURING THE MEETING

ROLL CALL: CHAIR KNIGHT, VICE CHAIR NGUYEN
MEMBERS BRADY, LADD, TACKNEY

PLEDGE OF ALLEGIANCE TO THE FLAG OF THE UNITED STATES OF AMERICA

- A. SELECTION OF CHAIR AND VICE CHAIR
- B. ORAL COMMUNICATIONS
- C. [RECEIVE AND FILE MINUTES – JUNE 28, 2023](#)
- D. [CODE OF ETHICS](#)
- E. [OVERVIEW OF BROWN ACT](#)
- F. HEARING(S) (Authorization for the Chair to execute Resolution shall be included in the motion.)

- F.1. [WATER BILLING APPEAL FROM HOANG VIET VAN -11632 ANABEL AVENUE](#)
- F.2. [WATER BILLING APPEAL FROM EDGAR ROJAS – 12001 WEST STREET](#)
- F.3. [WATER BILLING APPEAL FROM NGAN NGUYEN -13349 RAMONA DRIVE](#)
- G. [MATTERS FROM BOARD](#)
- H. [MATTERS FROM STAFF](#)
- I. [ADJOURNMENT](#)

GARDEN GROVE
ADMINISTRATIVE BOARD OF APPEALS (ABOA)
Community Meeting Center
11300 Stanford Avenue, Garden Grove, CA 92840

Special Meeting Minutes
Thursday, June 28, 2023

CALL TO ORDER: 6:00 p.m.

ROLL CALL:

Commissioner Brady
Commissioner Knight
Commissioner Ladd
Commissioner Nguyen
Commissioner Tackney

Absent: Tackney

STAFF PRESENT: Omar Sandoval, City Attorney; David Dent, Chief Building Official/Executive Secretary to the Board; Sam Kim, Water Services Manager; Les Ruitenschild, Public Works Supervisor; Tina Ngo, Accounting Supervisor; Judith Moore, Recording Secretary.

PLEDGE OF ALLEGIANCE: Led by Commissioner Ladd

ORAL COMMUNICATIONS – PUBLIC – None.

April 19, 2023 MINUTES:

Action: Received and filed.
Motion: Tackney Second: Ladd
Ayes: (4) Knight, Ladd, Nguyen, Tackney
Noes: (0) None
Absent: (1) Brady

HEARING – WATER BILLING APPEAL FROM SOUTHLAND PLAZA, LLC (CONTINUED FROM APRIL 19, 2023)

Appellant: SOUTHLAND PLAZA, LLC
Date: June 28, 2023

Request: Appellant requests that the Administrative Board of Appeals approve their appeal filed on February 21, 2023 for two bi-monthly billing periods (8/15/22-10/15/22;

10/16/22-12/20/22) for the property located at 14372 Brookhurst Street. Appellant alleges (1) a leak from the water meter that affects the customer's measured consumption should be fixed by City personnel (2) a high water bill resulting from a leak from a water meter should be credited once the leak has been fixed by City personnel, based on the increased water use above average water consumption during the bi-monthly periods (8/16/22-10/15/22; 10/1/22-12/20/22), and (3) Southland's determination that the leak not addressed by City in a timely manner was the sole cause of the higher water bill. Appellant seeks a reduction of charges as follows: (1) Billing period 8/15/22 to 10/15/22, original charges of \$13,342.25 to be adjusted to \$4,467.34; (2) Billing period 10/16/22 to 12/20/22, original charges of \$12,806.45 to be adjusted to \$4,786.94. Appellant further requests credits for payments made for the first water bill in the amount of \$13,342.25, water meter test fee of \$400.00, and appeal fee of \$225.00 for a net credit of (\$4,712.97) to be applied to water account.

On April 19, 2023, the Item was continued to a future meeting date to allow staff to gather additional information requested by the Board: (1) Determine whether additional water meter testing be conducted; (2) List of tenants be provided for board review.

For the June 28, 2023 meeting, the supplemental information was provided to the Board as follows:

Due to the Apellant not hiring a third party water test, the City volunteered to conduct a second meter accuracy test on April 25, 2023, which resulted in 100.26% accuracy, meaning that the meter accurately measured water flow.

The City provided a list of business license information for tenants of the property to clarify the type of business activity at the property.

When the hearing was opened, the Apellant provided a handout, which stated there were no seasonal adjustments for water usage; that replacing the meter resulted in normal readings; and there were discrepancies with the meter tests on 12/8/22 and 4/25/23 proving either the meter had been manipulated or was dysfunctional. He therefore concluded the meter was not functioning properly and the amount charged in the invoice was inappropriate, with a credit due to the account.

The Commissioner's consensus was that the water usage should be better tracked to detect excessive water usage by tenants and that landlord should be able to solve the issue.

Action: Resolution No. 001-2023 was approved to deny the Appeal.

Motion: Ladd Second: Tackney

Ayes: (4) Knight, Ladd, Nguyen, Tackney

Noes: (0) None

Absent: (1) Brady

MATTERS FROM BOARD: None.

MATTERS FROM STAFF: None.

ADJOURNMENT: At 6:28 p.m.

Judith Moore
Recording Secretary

CODE OF ETHICS

Chapter 2.02 CODE OF ETHICS FOR PUBLIC OFFICERS AND EMPLOYEES

2.02.005 Code Review

All official boards, commissions, and committees of the City are to formally review the following Code of Ethics provided in this chapter with their members annually during their first meeting in the month of April. New members are to be provided a copy of the Code of Ethics for their review when they are appointed or elected to each board, commission, or committee. (2813 § 1, 2012; 1437 § 1, 1975)

2.02.010 Declaration of Policy

The proper operation of municipal government requires that public officials and employees be independent, impartial, and responsible to the people; that governmental decisions and policy be made in the proper channels of the governmental structure; and that public office not be used for personal gain. (2813 § 1, 2012; 1301 § 1, 1972)

2.02.020 Responsibilities of Public Office

Public officials are all elective officials of the City and the members of all official boards, commissions, and committees of the City. Public officials and employees are bound to uphold the Constitution of the United States and the Constitution of the State and to carry out the laws of the nation, state, and municipality. Public officials and employees are bound to observe in their official acts the highest standards of morality and to discharge faithfully the duties of their offices, regardless of personal considerations; recognizing that the public interest must be their primary concern, and that conduct in both their official and private affairs should be above reproach. (2813 § 1, 2012; 1301 § 1, 1972)

2.02.030 Dedicated Service

Public officials and employees should not exceed their authority or breach the law or ask others to do so, and they should work in full cooperation with other public officials and employees unless prohibited from so doing by law or the officially recognized confidentiality of their work. (2813 § 1, 2012; 1301 § 1, 1972)

2.02.040 Fair and Equal Treatment

Preferential consideration of the request or petition of any individual citizen or group of citizens shall not be given. No person shall receive special advantages beyond that which are available to any other citizen. (2813 § 1, 2012; 1301 § 1, 1972)

2.02.050 Use of Public Property

No public official or employee shall request or permit the use of City-owned vehicles, equipment, materials, or property for personal convenience or profit, except when such services are available to the public generally or are provided as municipal policy for the use of such public official or employee in the conduct of official business. No public official or employee shall use the time of any City employee during working hours for personal convenience or profit. (2813 § 1, 2012; 1301 § 1, 1972)

2.02.060 Obligations to Citizens

A. CONFLICT WITH PROPER DISCHARGE OF DUTIES. No public official or employee, while serving as such, shall have any interest, financial or otherwise, direct or indirect, or engage in any business or transaction or

professional activity, or incur any obligation of any nature that is in substantial conflict with the proper discharge of his or her duties in the public interest and of his or her responsibilities as prescribed by law.

B. **INCOMPATIBLE EMPLOYMENT.** No public official or employee shall accept other employment that he or she has reason to believe will either impair his or her independence of judgment as to his or her official duties or require him or her or induce him or her to disclose confidential information acquired by him or her in the course of and by reason of his or her official duties.

C. **DISCLOSURE OF CONFIDENTIAL INFORMATION.** No public official or employee shall willfully and knowingly disclose for pecuniary gain to any other person confidential information acquired by him or her in the course of and by reason of his or her official duties nor shall any public official or employee use any such information for the purpose of pecuniary gain.

D. **CONFLICT OF INTEREST.** A conflict of interest exists in a matter before a public official for consideration or determination if:

1. The public official has a substantial financial or substantial personal interest in the outcome or as owner, member, partner, officer, employee, or stockholder of any corporation or other professional enterprise that will be affected by the outcome, and such interest is or may be adverse to the public interest in the proper performance of governmental duties by the public official;

2. The public official has reason to believe or expect that he or she will derive direct monetary gain or suffer a direct monetary loss, as the case may be, by reason of his or her official activity;

3. The public official, because of bias, prejudice, or because he or she has prejudged a matter set for public hearing, is incapable because of such bias, prejudice or prejudgment of granting to the matter before him or her a fair and impartial hearing.

4. Personal interest as distinguished from financial interest is defined as including, among other matters, an interest arising from blood or marriage relationships, or close business association. (2813 § 1, 2012; 1301 § 1, 1972)

2.02.070 Disclosure of Interest and Disqualification

A. Any Councilmember who has a conflict of interest as defined herein, in any matter before the City Council, shall disclose such fact on the record of the City Council and refrain from participating in any discussion of voting thereon, provided that such exceptions shall be observed as are required by law.

B. Any member of any official board, commission, or committee who has a conflict of interest as defined herein in any matter before the board, commission, or committee of which he or she is a member, shall disclose such fact on the record of such board, commission, or committee and refrain from participating in any discussion or voting thereon, provided that such exceptions shall be observed as are required by law.

C. Any employee who has a financial or other special interest in a matter before the City Council or any board, commission, or committee and who participates in discussion with, or gives an official opinion to the City Council, or to such board, commission, or committee relating to such matter, shall disclose on the record of the City Council or such board, commission, or committee, as the case may be, the nature and extent of such interest. (2813 § 1, 2012; 1301 § 1, 1972)

2.02.080 Compliance with State Law

Public officials and employees of the City shall comply with applicable provisions of state law relative to conflicts of interest and generally regulating the conduct of public officials and employees. (2813 § 1, 2012; 1301 § 1, 1972)

2.02.090 Violations—Actions

The violation of any provision of this chapter shall be:

A. As to all City employees, grounds for dismissal from City employment;

B. As to any appointed position on any board, commission, or committee, grounds for removal from any such board, commission, or committee;

C. As to any prosecution of any elected public official, the City Council shall make findings of fact by at least a vote of three City Councilmembers that an elected public official has, in fact, violated this chapter as a prerequisite to prosecution. (2813 § 1, 2012; 1301 § 1, 1972)

2.02.100 State Laws—Control

This chapter and its application are intended to be supplemental to and consistent with all applicable state laws. (2813 § 1, 2012; 1301 § 1, 1972)

2.02.110 Violations—Penalty

Any person violating any of the provisions of this chapter is guilty of a misdemeanor and, upon conviction thereof, is punishable as provided in Section 1.04.010 of this Code. (2813 § 1, 2012; 1301 § 1, 1972)

View the [mobile version](#).

BROWN ACT

Open & Public VI

A GUIDE TO THE RALPH M. BROWN ACT

REVISED JANUARY 2024



LEAGUE OF
CALIFORNIA
CITIES

Photo credit: Courtesy of the City of West Hollywood. Photo by Jon Viscott.

ACKNOWLEDGMENTS

Cal Cities thanks the following individuals for their work on this publication:

Brown Act Committee

Tracy M. Noonan, Committee Chair
City Attorney, Thousand Oaks

Amy Ackerman
Town Attorney, Corte Madera; Renne Public Law Group

Sheri Damon
City Attorney, Seaside

Christopher Diaz
City Attorney, Colma and Hillsborough
Best Best & Krieger LLP

Megan J. Marevich
Assistant City Attorney, Mountain View

Javan N. Rad
Chief Assistant City Attorney, Pasadena

Prasanna W. Rasiah
City Attorney, San Mateo

Sujata Reuter
Chief Assistant City Attorney, Santa Clara

Robert Schultz
Attorney

Frank A. Splendorio
City Attorney, Atwater and Plymouth
Best Best & Krieger LLP

Osa Wolff
City Attorney, Orinda
Shute, Mihaly & Weinberger LLP

Cal Cities Staff

Sheri Chapman, *General Counsel*

Alison Leary, *Senior Deputy General Counsel*

Janet Leonard, *Executive Assistant, Legal Services*



Open & Public VI

A GUIDE TO THE RALPH M. BROWN ACT
 REVISED JANUARY 2024

CHAPTER 1: IT IS THE PEOPLE’S BUSINESS.....5

CHAPTER 2: LEGISLATIVE BODIES.....11

CHAPTER 3: MEETINGS17

CHAPTER 4: AGENDAS, NOTICES, AND PUBLIC PARTICIPATION29

CHAPTER 5: CLOSED SESSIONS41

CHAPTER 6: REMEDIES55

TABLE OF CONTENTS

CHAPTER 1: IT IS THE PEOPLE’S BUSINESS	5
The right of access	6
Broad coverage	6
Narrow exemptions	7
Public participation in meetings	7
Controversy	8
Beyond the law — good business practices.....	8
Achieving balance	9
Historical note	9
CHAPTER 2: LEGISLATIVE BODIES	11
What is a “legislative body” of a local agency?	12
What is <u>not</u> a “legislative body” for purposes of the Brown Act?	14
CHAPTER 3: MEETINGS	17
Brown Act meetings.....	18
Six exceptions to the meeting definition	18
Collective briefings.....	21
Retreats, trainings, and workshops of legislative bodies.....	21
Serial meetings.....	22
Informal gatherings	24
Technological conferencing	25
Location of meetings.....	26
CHAPTER 4: AGENDAS, NOTICES, AND PUBLIC PARTICIPATION	29
Agendas for regular meetings.....	30
Mailed agenda upon written request.....	31
Notice requirements for special meetings	32
Notices and agendas for adjourned and continued meetings and hearings	32
Notice requirements for emergency meetings	33
Notice of compensation for simultaneous or serial meetings	33
Educational agency meetings.....	33
Notice requirements for tax or assessment meetings and hearings.....	33

Non-agenda items.....	34
Responding to the public.....	35
The right to attend and observe meetings.....	36
Records and recordings.....	37
The public’s right to speak during a meeting.....	38
CHAPTER 5: CLOSED SESSIONS	41
Agendas and reports.....	42
Litigation.....	43
Real estate negotiations.....	45
Public employment.....	46
Labor negotiations.....	47
Labor negotiations — school and community college districts.....	48
Other Education Code exceptions.....	48
Joint powers authorities.....	48
License applicants with criminal records.....	49
Public security.....	49
Multijurisdictional law enforcement agency.....	49
Hospital peer review and trade secrets.....	49
Other legislative bases for closed session.....	50
Who may attend closed sessions.....	50
The confidentiality of closed session discussions.....	51
CHAPTER 6: REMEDIES	55
Invalidation of action taken.....	56
Declaratory relief to determine whether past action violated the act.....	57
Civil action to prevent future violations.....	57
Costs and attorney’s fees.....	58
Misdemeanor penalties.....	58
Voluntary resolution.....	59





Chapter 1

IT IS THE PEOPLE’S BUSINESS

The right of access.....	6
Broad coverage	6
Narrow exemptions	7
Public participation in meetings	7
Controversy.....	8
Beyond the law — good business practices	8
Achieving balance	9
Historical note.....	9

Chapter 1

IT IS THE PEOPLE'S BUSINESS



The right of access

Two key parts of the Brown Act have not changed since its adoption in 1953. One is the act's initial section, declaring the Legislature's intent:

"In enacting this chapter, the Legislature finds and declares that the public commissions, boards and councils and the other public agencies in this State exist to aid in the conduct of the people's business. It is the intent of the law that their actions be taken openly and that their deliberations be conducted openly.

"The people of this State do not yield their sovereignty to the agencies which serve them. The people, in delegating authority, do not give their public servants the right to decide what is good for the people to know and what is not good for them to know. The people insist on remaining informed so that they may retain control over the instruments they have created."¹

The people reconfirmed that intent 50 years later in the November 2004 election by adopting Proposition 59, amending the California Constitution to include a public right of access to government information:

"The people have the right of access to information concerning the conduct of the people's business, and, therefore, the meetings of public bodies and the writings of public officials and agencies shall be open to public scrutiny."²

The Brown Act's other unchanged provision is a single sentence:

"All meetings of the legislative body of a local agency shall be open and public, and all persons shall be permitted to attend any meeting of the legislative body of a local agency, except as otherwise provided in this chapter."³

That one sentence is by far the most important of the entire Brown Act. If the opening is the soul, that sentence is the heart of the Brown Act.

Broad coverage

The Brown Act covers members of virtually every type of local government body, elected or appointed, decision-making or advisory. Some types of private organizations are covered, as are newly elected members of a legislative body, even before they take office.

Similarly, meetings subject to the Brown Act are not limited to face-to-face gatherings. They also include any communication medium or device through which a majority of a legislative body discusses, deliberates, or takes action on an item of business outside of a noticed meeting. They include meetings held from remote locations by teleconference or videoconference.

PRACTICE TIP: The key to the Brown Act is a single sentence. In summary, all meetings shall be **open and public** except when the Brown Act authorizes otherwise.

New communication technologies present new Brown Act challenges. For example, common email practices of forwarding or replying to messages can easily lead to a serial meeting prohibited by the Brown Act, as can participation by members of a legislative body in an internet chatroom or blog dialogue. Social Media posts, comments, and “likes” can result in a Brown Act violation. Communicating during meetings using electronic technology (such as laptop computers, tablets, or smart phones) may create the perception that private communications are influencing the outcome of decisions, and some state legislatures have banned the practice. On the other hand, widespread video streaming and videoconferencing of meetings has greatly expanded public access to the decision-making process.

Narrow exemptions

The express purpose of the Brown Act is to ensure that local government agencies conduct the public’s business openly and publicly. Courts and the California Attorney General usually broadly construe the Brown Act in favor of greater public access and narrowly construe exemptions to its general rules.⁴

Generally, public officials should think of themselves as living in glass houses, and that they may only draw the curtains when it is in the public interest to preserve confidentiality. Closed sessions may be held only as specifically authorized by the provisions of the Brown Act itself.

The Brown Act, however, is limited to meetings among a majority of the members of multimember government bodies when the subject relates to local agency business. It does not apply to independent conduct of individual decision-makers. It does not apply to social, ceremonial, educational, and other gatherings as long as a majority of the members of a body do not discuss issues related to their local agency’s business. Meetings of temporary advisory committees — as distinguished from standing committees — made up solely of less than a quorum of a legislative body are not subject to the Brown Act.

The law does not apply to local agency staff or employees, but they may facilitate a violation by acting as a conduit for discussion, deliberation, or action by the legislative body.⁵

The law, on the one hand, recognizes the need of individual local officials to meet and discuss matters with their constituents and staff. On the other hand, it requires — with certain specific exceptions to protect the community and preserve individual rights — that the decision-making process be public. Sometimes the boundary between the two is not easy to draw.

Public participation in meetings

In addition to requiring the public’s business to be conducted in open, noticed meetings, the Brown Act also extends to the public the right to participate in meetings. Individuals, lobbyists, and members of the news media possess the right to attend, record, broadcast, and participate in public meetings. The public’s participation is further enhanced by the Brown Act’s requirement that a meaningful agenda be posted in advance of meetings, by limiting discussion and action to matters listed on the agenda, and by requiring that meeting materials be made available.

Legislative bodies may, however, adopt reasonable regulations on public testimony and the conduct of public meetings, including measures to address disruptive conduct and limits on the time allotted to each speaker. For more information, see chapter 4.

PRACTICE TIP: Think of the government’s house as being made of glass. The curtains may be drawn only to further the public’s interest. A local policy on the use of laptop computers, tablets, and smart phones during Brown Act meetings may help avoid problems.

Controversy

Not surprisingly, the Brown Act has been a source of confusion and controversy since its inception. News media and government watchdogs often argue the law is toothless, pointing out that there has never been a single criminal conviction for a violation. They often suspect that closed sessions are being misused.

Some public officials complain that the Brown Act makes it difficult to respond to constituents and requires public discussions of items better discussed privately, such as why a particular person should not be appointed to a board or commission. Many elected officials find the Brown Act inconsistent with their private business experiences. Closed meetings can be more efficient; they eliminate grandstanding and promote candor. The techniques that serve well in business — the working lunch, the sharing of information through a series of phone calls or emails, the backroom conversations and compromises — are often not possible under the Brown Act.

As a matter of public policy, California (along with many other states) has concluded that there is more to be gained than lost by conducting public business in the open. Government behind closed doors may well be efficient and businesslike, but it may be perceived as unresponsive and untrustworthy.

Beyond the law — good business practices

Violations of the Brown Act can lead to invalidation of an agency's action, payment of a challenger's attorney fees, public embarrassment, even criminal prosecution. But the Brown Act is a floor, not a ceiling, for conduct of public officials. This guide is focused not only on the Brown Act as a minimum standard, but also on meeting practices or activities that, legal or not, are likely to create controversy. Problems may crop up, for example, when agenda descriptions are too brief or vague, when an informal get-together takes on the appearance of a meeting, when an agency conducts too much of its business in closed session or discusses matters in closed session that are beyond the authorized scope, or when controversial issues arise that are not on the agenda.

The Brown Act allows a legislative body to adopt practices and requirements for greater access to meetings for itself and its subordinate committees and bodies that are more stringent than the law itself requires.⁶ Rather than simply restate the basic requirements of the Brown Act, local open meeting policies should strive to anticipate and prevent problems in areas where the Brown Act does not provide full guidance. As with the adoption of any other significant policy, public comment should be solicited.

A local policy could build on these basic Brown Act goals:

- A legislative body's need to get its business done smoothly.
- The public's right to participate meaningfully in meetings, and to review documents used in decision-making at a relevant point in time.

PRACTICE TIP: Transparency is a foundational value for ethical government practices. The Brown Act is a floor, not a ceiling, for conduct.



- A local agency's right to confidentially address certain negotiations, personnel matters, claims, and litigation.
- The right of the press to fully understand and communicate public agency decision-making.

A detailed and comprehensive public meeting and information policy, especially if reviewed periodically, can be an important element in maintaining or improving public relations. Such a policy exceeds the absolute requirements of the law — but if the law were enough, this guide would be unnecessary. A narrow legalistic approach will not avoid or resolve potential controversies. An agency should consider going beyond the law and look at its unique circumstances to determine if there is a better way to prevent potential problems and promote public trust. At the very least, local agencies need to think about how their agendas are structured in order to make Brown Act compliance easier. They need to plan carefully to make sure public participation fits smoothly into the process.

Achieving balance

The Brown Act should be neither an excuse for hiding the ball nor a mechanism for hindering efficient and orderly meetings. The Brown Act represents a balance among the interests of constituencies whose interests do not always coincide. It calls for openness in local government, yet should allow government to function responsively and productively.

There must be both adequate notice of what discussion and action are to occur during a meeting as well as a normal degree of spontaneity in the dialogue between elected officials and their constituents.

The ability of an elected official to confer with constituents or colleagues must be balanced against the important public policy prohibiting decision-making outside of public meetings.

In the end, implementation of the Brown Act must ensure full participation of the public and preserve the integrity of the decision-making process, yet not stifle government officials and impede the effective and natural operation of government.

Historical note

In late 1951, *San Francisco Chronicle* reporter Mike Harris spent six weeks looking into the way local agencies conducted meetings. State law had long required that business be done in public, but Harris discovered secret meetings or caucuses were common. He wrote a 10-part series titled "Your Secret Government" that ran in May and June 1952.

Out of the series came a decision to push for a new state open-meeting law. Harris and Richard (Bud) Carpenter, legal counsel for the League of California Cities, drafted such a bill and Assembly Member Ralph M. Brown agreed to carry it. The Legislature passed the bill, and Governor Earl Warren signed it into law in 1953.

The Ralph M. Brown Act, known as the Brown Act, has evolved under a series of amendments and court decisions, and has been the model for other open-meeting laws, such as the Bagley-Keene Act, enacted in 1967 to cover state agencies.

Assembly Member Brown is best known for the open-meeting law that carries his name. He was elected to the Assembly in 1942 and served 19 years, including the last three years as Speaker. He then became an appellate court justice.

PRACTICE TIP: The Brown Act should be viewed as a tool to facilitate the business of local government agencies. Local policies that go beyond the minimum requirements of law may help instill public confidence and avoid problems.

Updates to this publication responding to changes in the Brown Act or new court interpretations are available at <https://www.calcities.org/home/resources/open-government2>. A current version of the Brown Act may be found at <https://leginfo.ca.gov>.

ENDNOTES

- 1 Cal. Gov. Code, § 54950.
- 2 Cal. Const., Art. 1, § 3, subd. (b)(1).
- 3 Cal. Gov. Code, § 54953, subd. (a).
- 4 This principle of broad construction when it furthers public access and narrow construction if a provision limits public access is also stated in the amendment to the State's Constitution adopted by Proposition 59 in 2004. California Const., Art. 1, § 3, subd. (b)(2).
- 5 Cal. Gov. Code, § 54952.2, subds. (b)(2) and (c)(1); *Wolfe v. City of Fremont* (2006) 144 Cal.App.4th 533.
- 6 Cal. Gov. Code, § 54953.7.



Chapter 2

LEGISLATIVE BODIES

What is a “legislative body” of a local agency? 12

What is not a “legislative body” for purposes of the Brown Act? 14

Chapter 2

LEGISLATIVE BODIES

The Brown Act applies to the legislative bodies of local agencies. It defines “legislative body” broadly to include just about every type of decision-making body of a local agency.¹



What is a “legislative body” of a local agency?

A “legislative body” includes the following:

- The “**governing body** of a local agency” and certain of its subsidiary bodies; “or any other local body created by state or federal statute.”² This includes city councils, boards of supervisors, school boards, and boards of trustees of special districts. A “local agency” is any city, county, city and county, school district, municipal corporation, successor agency to a redevelopment agency, district, political subdivision, or other local public agency.³ A housing authority is a local agency under the Brown Act even though it is created by and is an agent of the state.⁴ The California Attorney General has opined that air pollution control districts and regional open space districts are also covered.⁵ Entities created pursuant to joint powers agreements are also local agencies within the meaning of the Brown Act.⁶

- **Newly elected members** of a legislative body who have not yet assumed office must conform to the requirements of the Brown Act as if already in office.⁷ Thus, meetings between incumbents and newly elected members of a legislative body, such as a meeting between two outgoing members and a member-elect of a five-member body, could violate the Brown Act.

Q. On the morning following the election to a five-member legislative body of a local agency, two successful candidates, neither an incumbent, meet with an incumbent member of the legislative body for a celebratory breakfast. Does this violate the Brown Act?

A. *It might, and absolutely would if the conversation turns to agency business. Even though the candidates-elect have not officially been sworn in, the Brown Act applies. If purely a social event, there is no violation, but it would be preferable if others were invited to attend to avoid the appearance of impropriety.*

PRACTICE TIP: The prudent presumption is that an advisory committee or task force is subject to the Brown Act. Even if one clearly is not, it may want to comply with the Brown Act. Public meetings may reduce the possibility of misunderstandings and controversy.

- **Appointed bodies** — whether permanent or temporary, decision-making or advisory — including planning commissions, civil service commissions, and other subsidiary committees, boards, and bodies. Volunteer groups, executive search committees, task forces, and blue ribbon committees created by formal action of the governing body are legislative bodies. When the members of two or more legislative bodies are appointed to serve on an entirely separate advisory group, the resulting body may be subject to the Brown Act. In one reported case, a city council created a committee of two members of the city council and two members of the city planning commission to review qualifications of prospective planning commissioners and make recommendations to the council. The court held that their joint mission made them a legislative body subject to the Brown Act. Had the two committees remained separate and met only to exchange information and report back to their respective boards, they would have been exempt from the Brown Act.⁸
- **Standing committees** of a legislative body, irrespective of their composition, which have either (1) a continuing subject matter jurisdiction or (2) a meeting schedule fixed by charter, ordinance, resolution, or formal action of a legislative body.⁹ Even if it comprises less than a quorum of the governing body, a standing committee is subject to the Brown Act. For example, if a governing body creates committees on budget and finance or on public safety that are not limited in duration or scope, those are standing committees subject to the Brown Act. Further, according to the California Attorney General, function over form controls. For example, a statement by the legislative body that the advisory committee “shall not exercise continuing subject matter jurisdiction” or the fact that the committee does not have a fixed meeting schedule is not determinative.¹⁰ “Formal action” by a legislative body includes authorization given to the agency’s executive officer to appoint an advisory committee pursuant to agency-adopted policy.¹¹ A majority of the members of a legislative body may attend an open and public meeting of a standing committee of that body, provided the members who are not part of the standing committee only observe.¹² For more information, see chapter 3.
- The governing body of any **private organization** either (1) created by the legislative body in order to exercise authority that may lawfully be delegated by such body to a private corporation, limited liability company, or other entity or (2) that receives agency funding and whose governing board includes a member of the legislative body of the local agency appointed by the legislative body as a full voting member of the private entity’s governing board.¹³ These include some nonprofit corporations created by local agencies.¹⁴ If a local agency contracts with a private firm for a service (for example, payroll, janitorial, or food services), the private firm is not covered by the Brown Act.¹⁵ When a member of a legislative body sits on a board of a private organization as a private person and is not appointed by the legislative body, the board will not be subject to the Brown Act. Similarly, when the legislative body appoints someone other than one of its own members to such boards, the Brown Act does not apply. Nor does it apply when a private organization merely receives agency funding.¹⁶

PRACTICE TIP: It can be difficult to determine whether a subcommittee of a body falls into the category of a standing committee or an exempt temporary committee. Suppose a committee is created to explore the renewal of a franchise or a topic of similarly limited scope and duration. Is it an exempt temporary committee or a nonexempt standing committee? The answer may depend on factors such as how meeting schedules are determined, the scope of the committee’s charge, or whether the committee exists long enough to have “continuing jurisdiction.”

- Q.** The local chamber of commerce is funded in part by the city. The mayor sits on the chamber's board of directors. Is the chamber board a legislative body subject to the Brown Act?
- A.** *Maybe. If the chamber's governing documents require the mayor to be on the board and the city council appoints the mayor to that position, the board is a legislative body. If, however, the chamber board independently appoints the mayor to its board, or the mayor attends chamber board meetings in a purely advisory capacity, it is not.*
- Q.** If a community college district board creates an auxiliary organization to operate a campus bookstore or cafeteria, is the board of the organization a legislative body?
- A.** *Yes. But if the district instead contracts with a private firm to operate the bookstore or cafeteria, the Brown Act would not apply to the private firm.*

- **Certain types of hospital operators.** A lessee of a hospital (or portion of a hospital) first leased under Health and Safety Code subsection 32121(p) after Jan. 1, 1994, which exercises "material authority" delegated to it by a local agency, whether or not such lessee is organized and operated by the agency or by a delegated authority.¹⁷

What is not a "legislative body" for purposes of the Brown Act?

- A temporary advisory committee composed **solely of less than a quorum** of the legislative body that serves a limited or single purpose, that is not perpetual, and that will be dissolved once its specific task is completed is not subject to the Brown Act.¹⁸ Temporary committees are sometimes called *ad hoc* committees, a term not used in the Brown Act. Examples include an advisory committee composed of less than a quorum created to interview candidates for a vacant position or to meet with representatives of other entities to exchange information on a matter of concern to the agency, such as traffic congestion.¹⁹
- Groups advisory to a single decision-maker or appointed by staff are not covered. The Brown Act applies only to committees created by formal action of the legislative body and not to committees created by others. A committee advising a superintendent of schools would not be covered by the Brown Act. However, the same committee, if created by formal action of the school board, would be covered.²⁰

- Q.** A member of the legislative body of a local agency informally establishes an advisory committee of five residents to advise her on issues as they arise. Does the Brown Act apply to this committee?
- A.** *No, because the committee has not been established by formal action of the legislative body.*
- Q.** During a meeting of the city council, the council directs the city manager to form an advisory committee of residents to develop recommendations for a new ordinance. The city manager forms the committee and appoints its members; the committee is instructed to direct its recommendations to the city manager. Does the Brown Act apply to this committee?
- A.** *Possibly, because the direction from the city council might be regarded as a formal action of the body, notwithstanding that the city manager controls the committee.*

- Individual decision-makers who are not elected or appointed members of a legislative body are not covered by the Brown Act. For example, a disciplinary hearing presided over by a department head or a meeting of agency department heads is not subject to the Brown Act since such assemblies are not those of a legislative body.²¹
- Public employees, each acting individually and not engaging in collective deliberation on a specific issue, such as the drafting and review of an agreement, do not constitute a legislative body under the Brown Act, even if the drafting and review process was established by a legislative body.²²
- County central committees of political parties are also not Brown Act bodies.²³

Legal counsel for a governing body is not a member of the governing body, therefore, the Brown Act does not apply to them. But counsel should take care not to facilitate Brown Act violations by members of the governing body.²⁴

ENDNOTES

- 1 *Taxpayers for Livable Communities v. City of Malibu* (2005) 126 Cal.App.4th 1123, 1127.
- 2 Cal. Gov. Code, § 54952, subs. (a) and (b).
- 3 Cal. Gov. Code, § 54951; Cal. Health & Saf. Code, § 34173, subd. (g) (successor agencies to former redevelopment agencies subject to the Brown Act). But see Cal. Ed. Code § 35147, which exempts certain school councils and school site advisory committees from the Brown Act and imposes upon them a separate set of rules.
- 4 *Torres v. Board of Commissioners of Housing Authority of Tulare County* (1979) 89 Cal.App.3d 545, 549-550.
- 5 71 Ops.Cal.Atty.Gen. 96 (1988); 73 Ops.Cal.Atty.Gen. 1 (1990).
- 6 *McKee v. Los Angeles Interagency Metropolitan Police Apprehension Crime Task Force* (2005) 134 Cal. App.4th 354, 362.
- 7 Cal. Gov. Code, § 54952.1.
- 8 *Joiner v. City of Sebastopol* (1981) 125 Cal.App.3d 799, 804-805.
- 9 Cal. Gov. Code, § 54952, subd. (b)
- 10 79 Ops.Cal.Atty.Gen. 69 (1996).
- 11 *Frazer v. Dixon Unified School District* (1993) 18 Cal.App.4th 781, 793.
- 12 Cal. Gov. Code § 54952, subd. (c)(6).
- 13 Cal. Gov. Code, § 54952, subd. (c)(1). Regarding private organizations that receive local agency funding, the same rule applies to a full voting member appointed prior to February 9, 1996, who, after that date, is made a nonvoting board member by the legislative body. Cal. Gov. Code § 54952, subd. (c)(2).
- 14 Cal. Gov. Code, § 54952(c)(1)(A); *International Longshoremen's and Warehousemen's Union v. Los Angeles Export Terminal, Inc.* (1999) 69 Cal.App.4th 287, 300; *Epstein v. Hollywood Entertainment Dist. II Business Improvement District* (2001) 87 Cal.App.4th 862, 876; see also 85 Ops.Cal.Atty.Gen. 55 (2002).
- 15 *International Longshoremen's and Warehousemen's Union v. Los Angeles Export Terminal, Inc.* (1999) 69 Cal.App.4th 287, 300 fn. 5.
- 16 "The Brown Act, Open Meetings for Local Legislative Bodies," California Attorney General's Office (2003), p. 7.

- 17 Cal. Gov. Code, § 54952, subd. (d).
- 18 Cal. Gov. Code, § 54952, subd. (b); see also *Freedom Newspapers, Inc. v. Orange County Employees Retirement System Board of Directors* (1993) 6 Cal.4th 821, 832.
- 19 *Taxpayers for Livable Communities v. City of Malibu* (2005) 126 Cal.App.4th 1123, 1129.
- 20 56 Ops.Cal.Atty.Gen. 14, 16-17 (1973).
- 21 *Wilson v. San Francisco Municipal Railway* (1973) 29 Cal.App.3d 870, 878-879.
- 22 *Golightly v. Molina* (2014) 229 Cal.App.4th 1501, 1513.
- 23 59 Ops.Cal.Atty.Gen. 162, 164 (1976).
- 24 *GFRCO, Inc. v. Superior Court of Riverside County* (2023) 89 Cal.App.5th 1295, 1323; *Stockton Newspapers, Inc. v. Redevelopment Agency of the City of Stockton* (1985) 171 Cal.App.3d 95, 105 (a series of individual telephone calls between the agency attorney and the members of the body constituted a meeting).



Chapter 3

MEETINGS

Brown Act meetings	18
Six exceptions to the meeting definition.....	18
Collective briefings.....	21
Retreats, trainings, and workshops of legislative bodies	21
Serial meetings	22
Informal gatherings	24
Technological conferencing	25
Location of meetings	26

Chapter 3

MEETINGS



The Brown Act only applies to meetings of local legislative bodies. It defines a meeting as “any congregation of a majority of the members of a legislative body at the same time and location, including teleconference location as permitted by Section 54953, to hear, discuss, deliberate, or take any action on any item that is within the subject matter jurisdiction of the legislative body.”¹ The term *meeting* is not limited to gatherings at which action is taken but includes deliberative gatherings as well. A hearing before an individual hearing officer is not a meeting under the Brown Act because it is not a hearing before a legislative body.²

Brown Act meetings

Brown Act meetings include a legislative body’s regular meetings, special meetings, emergency meetings, and adjourned meetings.

- **“Regular meetings”** are meetings occurring at the dates, times, and location set by resolution, ordinance, or other formal action by the legislative body and are subject to 72-hour posting requirements.³
- **“Special meetings”** are meetings called by the presiding officer or majority of the legislative body to discuss only discrete items on the agenda under the Brown Act’s notice requirements for special meetings and are subject to 24-hour posting requirements.⁴
- **“Emergency meetings”** are a limited class of meetings held when prompt action is needed due to actual or threatened disruption of public facilities and are held on little notice.⁵
- **“Adjourned meetings”** are regular or special meetings that have been adjourned or re-adjourned to a time and place specified in the order of adjournment, with no agenda required for regular meetings adjourned for less than five calendar days as long as no additional business is transacted.⁶

Six exceptions to the meeting definition

The Brown Act creates six exceptions to the meeting definition:⁷

Individual contacts

The first exception involves individual contacts between a member of the legislative body and any other person. The Brown Act does not limit a legislative body member acting on their own. This exception recognizes the right to confer with constituents, advocates, consultants, news reporters, local agency staff, or a colleague.

Individual contacts, however, cannot be used to do in stages what would be prohibited in one step. For example, a series of individual contacts that leads to discussion, deliberation, or action among a majority of the members of a legislative body is prohibited. Such serial meetings are discussed below.

Conferences

The second exception allows a legislative body majority to attend a conference or similar gathering open to the public that addresses issues of general interest to the public or to public agencies of the type represented by the legislative body.

Among other things, this exception permits legislative body members to attend annual association conferences of city, county, school, community college, and other local agency officials, as long as those meetings are open to the public. However, a majority of members cannot discuss among themselves, other than as part of the scheduled program, business of a specific nature that is within their local agency's subject matter jurisdiction.

Community meetings

The third exception allows a legislative body majority to attend an open and publicized meeting held by another organization to address a topic of local community concern. A majority cannot discuss among themselves, other than as part of the scheduled program, business of a specific nature that is within the legislative body's subject matter jurisdiction. Under this exception, a legislative body majority may attend a local service club meeting or a local candidates' night if the meetings are open to the public.

"I see we have four distinguished members of the city council at our meeting tonight," said the chair of the Environmental Action Coalition. "I wonder if they have anything to say about the controversy over enacting a slow growth ordinance?"

The Brown Act permits a majority of a legislative body to attend and speak at an open and publicized meeting conducted by another organization. The Brown Act may nevertheless be violated if a majority discusses, deliberates, or takes action on an item during the meeting of the other organization. There is a fine line between what is permitted and what is not; hence, members should exercise caution when participating in these types of events.

- Q.** The local chamber of commerce sponsors an open and public candidate debate during an election campaign. Three of the five agency members are up for reelection and all three participate. All of the candidates are asked their views on a controversial project scheduled for a meeting to occur just after the election. May the three incumbents answer the question?
- A.** Yes, because the chamber of commerce, not the city, is organizing the debate. The city should not sponsor the event or assign city staff to help organize or run the event. Also, the Brown Act does not constrain the incumbents from expressing their views regarding important matters facing the local agency as part of the political process the same as any other candidates. Finally, incumbents participating in the event should take care to limit their remarks to the program set by the chamber and safeguard due process by indicating they will keep an open mind regarding specific applications that might come before the council.
- Q.** May the three incumbents accept an invitation from the editorial board of a local paper to all candidates to meet as a group and answer questions about and/or debate city issues?
- A.** No, unlike the chamber of commerce event, this would not be allowed under the Brown Act because it is not an open and publicized meeting.

Other legislative bodies

The fourth exception allows a majority of a legislative body to attend an open and publicized meeting of (1) another body of the local agency and (2) a legislative body of another local agency.⁸ Again, the majority cannot discuss among themselves, other than as part of the scheduled meeting, business of a specific nature that is within their subject matter jurisdiction. This exception allows, for example, a city council or a majority of a board of supervisors to attend a controversial meeting of the planning commission.

Nothing in the Brown Act prevents the majority of a legislative body from sitting together at such a meeting. They may choose not to, however, to preclude any possibility of improperly discussing local agency business and to avoid the appearance of a Brown Act violation. Further, aside from the Brown Act, there may be other reasons, such as due process considerations, why the members should avoid giving public testimony, trying to influence the outcome of proceedings before a subordinate body, or discussing the merits with interested parties.

Q. The entire legislative body intends to testify against a bill before the Senate Local Government Committee in Sacramento. Must this activity be noticed as a meeting of the body?

A. *No, because the members are attending and participating in an open meeting of another governmental body that the public may attend.*

Q. The members then proceed upstairs to the office of their local assembly member to discuss issues of local interest. Must this session be noticed as a meeting and be open to the public?

A. *Yes, because the entire body may not meet behind closed doors except for proper closed sessions. The same answer applies to a private lunch or dinner with the assembly member.*

Standing committees

The fifth exception authorizes the attendance of a majority at an open and noticed meeting of a standing committee of the legislative body, provided that the legislative body members who are not members of the standing committee attend only as observers (meaning that they cannot speak or otherwise participate in the meeting, and they must sit where members of the public sit).⁹

Q. The legislative body establishes a standing committee of two of its five members that meets monthly. A third member of the legislative body wants to attend these meetings and participate. May she?

A. *She may attend, but only as an observer; she may not participate.*

Q. Can the legislative body establish multiple standing committees with partially overlapping jurisdiction?

A. *Yes. One result of this overlap in jurisdiction may be that three or more of the members of the legislative body ultimately end up discussing an issue as part of a standing committee meeting. This is allowed under the Brown Act provided each standing committee meeting is publicly noticed and no more than two of the five members discuss the issue at any given standing committee meeting.*

Social or ceremonial events

The final exception permits a majority of a legislative body to attend a purely social or ceremonial occasion. Once again, a majority cannot discuss business among themselves of a specific nature that is within the subject matter jurisdiction of the legislative body.

Nothing in the Brown Act prevents a majority of members from attending the same football game, party, wedding, funeral, reception, or farewell. The test is not whether a majority of a legislative body attend the function, but whether business of a specific nature within the subject matter jurisdiction of the body is discussed. As long as no such business is discussed, there is no violation of the Brown Act.

Grand Jury Testimony

In addition, members of a legislative body, either individually or collectively, may give testimony in private before a grand jury.¹⁰ This is the equivalent of a seventh exception to the Brown Act's definition of a "meeting."

Collective briefings

None of these exceptions permits a majority of a legislative body to meet together with staff in advance of a meeting for a collective briefing. Any such briefings that involve a majority of the body in the same place and time must be open to the public and satisfy Brown Act meeting notice and agenda requirements. Staff may provide written briefings (e.g., staff updates, emails from the city manager, confidential memos from the city attorney) to the full legislative body, but apart from privileged memos, the written materials may be subject to disclosure as public records as discussed in chapter 4.

Retreats, trainings, and workshops of legislative bodies

Gatherings by a majority of legislative body members at the legislative body's retreats, study sessions, trainings, or workshops are subject to the requirements of the Brown Act. This is the case whether the gathering focuses on long-range agency planning, discussion of critical local issues, satisfying state-mandated ethics training requirements, or team building and group dynamics.¹¹



- Q.** The legislative body wants to hold a team-building session to improve relations among its members. May such a session be conducted behind closed doors?
- A.** *No, this is not a proper subject for a closed session, and there is no other basis to exclude the public. Council relations are a matter of public business.*

Serial meetings

One of the most frequently asked questions about the Brown Act involves serial meetings. At any one time, such meetings include only a portion of a legislative body, but eventually they comprise a majority. The Brown Act provides that “[a] majority of the members of a legislative body shall not, outside a meeting ... use a series of communications of any kind, directly or through

intermediaries, to discuss, deliberate, or take action on any item of business that is within the subject matter jurisdiction of the legislative body.”¹² The problem with serial meetings is the process, which deprives the public of an opportunity for meaningful observation of and participation in legislative body decision-making.

The serial meeting may occur by either a “daisy chain” or a “hub and spoke” sequence. In the daisy chain scenario, Member A contacts Member B, Member B contacts Member C, Member C contacts Member D, and so on until a quorum has discussed, deliberated, or taken action on an item within the legislative body’s subject matter jurisdiction. The hub and spoke process involves at least two scenarios. In the first scenario, Member A (the hub) sequentially contacts Members B, C, D, and so on (the spokes) until a quorum has been contacted. In the second scenario, a staff member (the hub), functioning as an intermediary for the legislative body

or one of its members, communicates with a majority of members (the spokes) one by one for discussion, deliberation, or a decision on a proposed action.¹³ Another example of a serial meeting is when a chief executive officer (the hub) briefs a majority of members (the spokes) prior to a formal meeting and, in the process, information about the members’ respective views is revealed. Each of these scenarios violates the Brown Act.

A legislative body member has the right, if not the duty, to meet with constituents to address their concerns. That member also has the right to confer with a colleague (but not with a majority of the body, counting the member) or appropriate staff about local agency business. An employee or official of a local agency may engage in separate conversations or communications outside of an open and noticed meeting “with members of a legislative body in order to answer questions or provide information regarding a matter that is within the subject matter jurisdiction of the local agency if that person does not communicate to members of the legislative body the comments or position of any other member or members of the legislative body.”¹⁴

The Brown Act is violated, however, if several one-on-one meetings or conferences lead to a discussion, deliberation, or action by a majority. In one case, a violation occurred when a quorum



Photo credit: Courtesy of the City of West Hollywood. Photo by Jon Viscott.

of a city council, by a letter that had been circulated among members outside of a formal meeting, directed staff to take action in an eminent domain proceeding.¹⁵

A unilateral written communication to the legislative body, such as an informational or advisory memorandum, does not violate the Brown Act.¹⁶ Such a memo, however, may be a public record.¹⁷

The phone call was from a lobbyist. “Say, I need your vote for that project in the south area. How about it?”

“Well, I don’t know,” replied Board Member Aletto. “That’s kind of a sticky proposition. You sure you need my vote?”

“Well, I’ve got Bradley and Cohen lined up and another vote leaning. With you, I’d be over the top.”

Moments later, the phone rings again. “Hey, I’ve been hearing some rumbles on that south area project,” said the newspaper reporter. “I’m counting noses. How are you voting on it?”

The lobbyist and the reporter are facilitating a violation of the Brown Act. The board member may have violated the Brown Act by hearing about the positions of other board members and indeed coaxing the lobbyist to reveal the other board members’ positions by asking, “You sure you need my vote?” The prudent course is to avoid such leading conversations and to caution lobbyists, staff, and news media against revealing such positions of others.

The mayor sat down across from the city manager. “From now on,” he declared, “I want you to provide individual briefings on upcoming agenda items. Some of this material is very technical, and the council members don’t want to sound like idiots asking about it in public. Besides that, briefings will speed up the meeting.”

Agency employees or officials may have separate conversations or communications outside of an open and noticed meeting “with members of a legislative body in order to answer questions or provide information regarding a matter that is within the subject matter jurisdiction of the local agency if that person does not communicate to members of the legislative body the comments or position of any other member or members of the legislative body.”¹⁸ Members should always be vigilant when discussing local agency business with anyone to avoid conversations that could lead to a discussion, deliberation, or action taken among the majority of the legislative body.

“Thanks for the information,” said Council Member Kim. “These zoning changes can be tricky, and now I think I’m better equipped to make the right decision.”

“Glad to be of assistance,” replied the planning director. “I’m sure Council Member Jones is OK with these changes. How are you leaning?”

“Well,” said Council Member Kim, “I’m leaning toward approval. I know that two of my colleagues definitely favor approval.”

PRACTICE TIP: When briefing legislative body members, staff must exercise care not to disclose other members’ views and positions.

The planning director should not disclose Jones' prospective vote, and Kim should not disclose the prospective votes of two colleagues. Under these facts, there likely has been a serial meeting in violation of the Brown Act.

- Q.** Various social media platforms and websites include forums where agency employees and officials can discuss issues of local agency business. Members of the legislative body participate regularly. Does this scenario present a potential for violation of the Brown Act?
- A.** *Yes, because it is a technological device that may serve to allow for a majority of members to discuss, deliberate, or take action on matters of agency business.*
- Q.** A member of a legislative body contacts two other members on a five-member body relative to scheduling a special meeting. Is this an illegal serial meeting?
- A.** *No, the Brown Act expressly allows a majority of a body to call a special meeting, though the members should avoid discussing the merits of what is to be taken up at the meeting.*

Particular care should be exercised when staff briefings of legislative body members occur by email because of the ease of using the “reply all” option that may inadvertently result in a Brown Act violation. Staff should consider using the “bcc” (blind carbon copy) option when addressing an email to multiple members of the legislative body and remind recipients not to “reply all.”

Social media should also be used with care. A member of the legislative body cannot respond directly to any communication on an internet-based social media platform that is made, posted, or shared by any other member of the legislative body. This applies to matters within the subject matter jurisdiction of the legislative body. For example, if one member of a legislative body “likes” a social media post of one other member of the same body, that could violate the Brown Act, depending on the nature of the post.¹⁹

Finally, electronic communications (such as text messaging) among members of a legislative body during a public meeting should be discouraged. If such communications are sent to a majority of members of the body, either directly or through an intermediary, on a matter on the meeting agenda, that could violate the Brown Act. Electronic communications sent to less than a majority of members of the body during a quasi-judicial proceeding could potentially raise due process concerns, even if not per se prohibited by the Brown Act. Additionally, some legislative bodies have rules governing electronic communications during meetings of the legislative body and how their members should proceed if they receive a communication on an agenda item that is not part of the record or not part of an agenda packet.

Informal gatherings

Members of legislative bodies are often tempted to mix business with pleasure — for example, by holding a post-meeting gathering. Informal gatherings at which local agency business is discussed or transacted violate the law if they are not conducted in conformance with the Brown Act.²⁰ A gathering at which a quorum of the legislative body discusses matters within their jurisdiction violates the Brown Act even if that gathering occurs in a public place. The Brown Act is not satisfied by public visibility alone. It also requires public notice and an opportunity to attend, hear, and participate.

Thursday at 11:30 a.m., as they did every week, the board of directors of the Dry Gulch Irrigation District trooped into Pop’s Donut Shoppe for an hour of talk and fellowship. They sat at the corner window, fronting on Main and Broadway, to show they had nothing to hide. Whenever he could, the managing editor of the weekly newspaper down the street hurried over to join the board.

A gathering like this would not violate the Brown Act if board members scrupulously avoided talking about irrigation district issues — which might be difficult. This kind of situation should be avoided. The public is unlikely to believe the board members could meet regularly without discussing public business. A newspaper executive’s presence does not lessen the potential for a violation of the Brown Act.

Technological conferencing

Except for certain non-substantive purposes, such as scheduling a special meeting, a conference call including a majority of the members of a legislative body is an unlawful meeting. But in an effort to keep up with modern technologies, the Brown Act specifically allows a legislative body to use any type of teleconferencing to meet, receive public comment and testimony, deliberate, or conduct a closed session.²¹ While the Brown Act contains specific requirements for conducting a teleconference, the decision to use teleconferencing is entirely discretionary with the body. No person has a right under the Brown Act to have a meeting by teleconference.

Teleconference is defined as “a meeting of a legislative body, the members of which are in different locations, connected by electronic means, through either audio or video, or both.”²² In addition to the specific requirements relating to teleconferencing, the meeting must comply with all provisions of the Brown Act otherwise applicable. The Brown Act contains the following teleconferencing requirements:²³

- Teleconferencing may be used for all purposes during any meeting.
- At least a quorum of the legislative body must participate from locations within the local agency’s jurisdiction.
- Additional teleconference locations may be made available for the public.
- Each teleconference location must be specifically identified in the notice and agenda of the meeting, including a full address and room number, as may be applicable.
- Agendas must be posted at each teleconference location, even if a hotel room or a residence.
- Each teleconference location, including a hotel room or residence, must be accessible to the public and have technology, such as a speakerphone, to enable the public to participate
- The agenda must provide the opportunity for the public to address the legislative body directly at each teleconference location.
- All votes must be by roll call.



Photo credit: Courtesy of the City of West Hollywood. Photo by Jon Viscott.

Q. A member on vacation wants to participate in a meeting of the legislative body and vote by cellular phone from her car while driving from Washington, D.C., to New York. May she?

A. *She may not participate or vote because she is not in an open, noticed, and posted teleconference location.*

Until Jan. 1, 2026, teleconferencing may also be used on a limited basis where a member indicates their need to participate remotely for “just cause” (e.g., childcare or a contagious illness) or due to

“emergency circumstances” (e.g., a physical or family medical emergency). This teleconferencing option has extremely detailed requirements, and careful review is needed. If the City experiences a technical issue that prevents members of the public from viewing the meeting and/or offering comments virtually, then no further action can be taken until the technical issue is resolved.²⁴

The use of teleconferencing to conduct a legislative body meeting presents a variety of issues beyond the scope of this guide to discuss in detail. Therefore, before teleconferencing a meeting, legal counsel for the local agency should be consulted.

Location of meetings

The Brown Act generally requires all regular and special meetings of a legislative body, including retreats and workshops, to be held within the boundaries of the territory over which the local agency exercises jurisdiction.²⁵

An open and publicized meeting of a legislative body may be held outside of agency boundaries if the purpose of the meeting is one of the following:²⁶

- Comply with state or federal law or a court order, or attend a judicial conference or administrative proceeding in which the local agency is a party.
- Inspect real or personal property that cannot be conveniently brought into the local agency’s territory, provided the meeting is limited to items relating to that real or personal property.

Q. The agency is considering approving a major retail mall. The developer has built other similar malls and invites the entire legislative body to visit a mall outside the jurisdiction. May the entire body go?

A. *Yes, the Brown Act permits meetings outside the boundaries of the agency for specified reasons and inspection of property is one such reason. The field trip must be treated as a meeting and the public must be allowed to attend.*

- Participate in multiagency meetings or discussions; however, such meetings must be held within the boundaries of one of the participating agencies, and all of those agencies must give proper notice.
- Meet in the closest meeting facility if the local agency has no meeting facility within its boundaries, or meet at its principal office if that office is located outside the territory over which the agency has jurisdiction.



- Meet with elected or appointed federal or California officials when a local meeting would be impractical, solely to discuss a legislative or regulatory issue affecting the local agency and over which the federal or state officials have jurisdiction.
- Meet in or nearby a facility owned by the agency, provided that the topic of the meeting is limited to items directly related to the facility.
- Visit the office of its legal counsel for a closed session on pending litigation when to do so would reduce legal fees or costs.²⁷

In addition, the governing board of a school or community college district may hold meetings outside of its boundaries to attend a conference on nonadversarial collective bargaining techniques, interview candidates for school district superintendent, or interview a potential employee from another district.²⁸ A school board may also interview members of the public residing in another district if the board is considering employing that district's superintendent.

Similarly, meetings of a joint powers authority can occur within the territory of at least one of its member agencies, and a joint powers authority with members throughout the state may meet anywhere in the state.²⁹

Finally, if a fire, flood, earthquake, or other emergency makes the usual meeting place unsafe, the presiding officer can designate another meeting place for the duration of the emergency. News media that have requested notice of meetings must be notified of the designation by the most rapid means of communication available.³⁰ State law has also allowed for virtual meetings under certain emergency situations.³¹

ENDNOTES

- 1 Cal. Gov. Code, § 54952.2, subd. (a).
- 2 *Wilson v. San Francisco Municipal Railway* (1973) 29 Cal.App.3d 870.
- 3 Cal. Gov. Code, § 54954, subd. (a).
- 4 Cal. Gov. Code, § 54956.
- 5 Cal. Gov. Code, § 54956.5.
- 6 Cal. Gov. Code, § 54955.
- 7 Cal. Gov. Code, § 54952.2, subd. (c).
- 8 Cal. Gov. Code, § 54952.2, subd. (c)(4).
- 9 Cal. Gov. Code, § 54952.2, subd. (c)(6). See 81 Ops.Cal.Atty.Gen. 156 (1998).
- 10 Cal. Gov. Code, § 54953.1.
- 11 "The Brown Act," California Attorney General (2003), p. 10.
- 12 Cal. Gov. Code, § 54952.2, subd. (b)(1).
- 13 *Stockton Newspapers, Inc. v. Redevelopment Agency of the City of Stockton* (1985) 171 Cal.App.3d 95.
- 14 Cal. Gov. Code, § 54952.2, subd. (b)(2).
- 15 *Common Cause v. Stirling* (1983) 147 Cal.App.3d 518.
- 16 *Roberts v. City of Palmdale* (1993) 5 Cal.4th 363.
- 17 Cal. Gov. Code, § 54957.5, subd. (a).
- 18 Cal. Gov. Code, § 54952.2, subd. (b)(2).
- 19 Cal. Gov. Code, § 54952.2, subd. (b)(3).

- 20 Cal. Gov. Code, § 54952.2; 43 Ops.Cal.Atty.Gen. 36 (1964).
- 21 Cal. Gov. Code, § 54953, subd. (b)(1).
- 22 Cal. Gov. Code, § 54953, subd. (b)(4).
- 23 Cal. Gov. Code, § 54953. Until Jan. 1, 2024, the legislative body could use teleconferencing “during a proclaimed state of emergency” by the Governor in specified circumstances, and teleconference locations were exempt from certain requirements, such as identification in and posting of the agenda.
- 24 Cal Gov. Code, § 54953, subd. (f) (which will become Govt. §54953(e) as of Jan. 1, 2024).
- 25 Cal. Gov. Code, § 54954, subd. (b).
- 26 Cal. Gov. Code, § 54954, subd. (b)(1)-(7).
- 27 94 Ops.Cal.Atty.Gen. 15 (2011).
- 28 Cal. Gov. Code, § 54954, subd. (c).
- 29 Cal. Gov. Code, § 54954, subd. (d).
- 30 Cal. Gov. Code, § 54954, subd. (e).
- 31 Cal. Gov. Code, § 54953, subd. (e) (exp. January 1, 2026).



Chapter 4

AGENDAS, NOTICES, AND PUBLIC PARTICIPATION

Agendas for regular meetings	30
Mailed agenda upon written request	31
Notice requirements for special meetings	32
Notices and agendas for adjourned and continued meetings and hearings	32
Notice requirements for emergency meetings	33
Notice of compensation for simultaneous or serial meetings	33
Educational agency meetings	33
Notice requirements for tax or assessment meetings and hearings	33
Non-agenda items	34
Responding to the public	35
The right to attend and observe meetings	36
Records and recordings	37
The public’s right to speak during a meeting	38

Chapter 4

AGENDAS, NOTICES, AND PUBLIC PARTICIPATION



Effective notice is essential for an open and public meeting. Whether a meeting is open or how the public may participate in that meeting is academic if nobody knows about the meeting.

Agendas for regular meetings

Every regular meeting of a legislative body of a local agency — including advisory committees, commissions, or boards, as well as standing committees of legislative bodies — must be preceded by a posted agenda that advises the public of the meeting and the matters to be transacted or discussed.

The agenda must be posted at least 72 hours before the regular meeting in a location “freely accessible to members of the public.”¹ The courts have not definitively interpreted the “freely accessible” requirement. The California Attorney General has interpreted this

provision to require posting in a location open and accessible to the public 24 hours a day during the 72-hour period, but any of the 72 hours may fall on a weekend.² This provision may be satisfied by posting on a touch screen electronic kiosk accessible without charge to the public 24 hours a day during the 72-hour period.³ While posting an agenda on an agency’s internet website will not, by itself, satisfy the “freely accessible” requirement since there is no universal access to the internet, an agency has a supplemental obligation to post the agenda on its website if (1) the local agency has a website and (2) the legislative body whose meeting is the subject of the agenda is either (a) a governing body or (b) has members that are compensated, with one or more members that are also members of a governing body.⁴

- Q.** May the meeting of a governing body go forward if its agenda was either inadvertently not posted on the city’s website or if the website was not operational during part or all of the 72-hour period preceding the meeting?
- A.** *At a minimum, the Brown Act calls for “substantial compliance” with all agenda posting requirements, including posting to the agency website.⁵ Should website technical difficulties arise, seek a legal opinion from your agency attorney. The California Attorney General has opined that technical difficulties that cause the website agenda to become inaccessible for a portion of the 72 hours preceding a meeting do not automatically or inevitably lead to a Brown Act violation, provided the agency can demonstrate substantial compliance.⁶ This inquiry requires a fact-specific examination of whether the agency or its legislative body made “reasonably effective efforts to notify interested persons of a public meeting” through online posting and other available means.⁷ The Attorney General’s opinion suggests that this examination would include an evaluation of how long a technical problem persisted, the efforts made to correct the problem or otherwise ensure that the public was informed, and the actual effect the problem had on public*

awareness, among other factors.⁸ For these reasons, obvious website technical difficulties might not require cancellation of a meeting, provided that the agency meets all other Brown Act posting requirements and the agenda is available on the website once the technical difficulties are resolved.

The agenda must state the meeting time and place and must contain “a brief general description of each item of business to be transacted or discussed at the meeting, including items to be discussed in closed session.”⁹ For a discussion of descriptions for open and closed-session agenda items, see chapter 5. Special care should be made to describe on the agenda each distinct action to be taken by the legislative body, while an overbroad description of a “project” must be avoided if the “project” is actually a set of distinct actions, in which case each action must be listed separately on the agenda.¹⁰ For example, the listing of an “initiative measure” alone on an agenda was found insufficient where the agency was also deciding whether to accept a gift from the measure proponent to pay for the election.¹¹

PRACTICE TIP: Putting together a meeting agenda requires careful thought.

Q. The agenda for a regular meeting contains the following items of business:

- Consideration of a report regarding traffic on Eighth Street.
- Consideration of a contract with ABC Consulting.

Are these descriptions adequate?

A. *If the first is, it is barely adequate. A better description would provide the reader with some idea of what the report is about and what is being recommended. The second is not adequate. A better description might read, “Consideration of a contract with ABC Consulting in the amount of \$50,000 for traffic engineering services regarding traffic on Eighth Street.”*

Q. The agenda includes an item entitled City Manager’s Report, during which time the city manager provides a brief report on notable topics of interest, none of which is listed on the agenda.

Is this permissible?

A. *Yes, as long as it does not result in extended discussion or action by the body.*

A brief general description may not be sufficient for closed-session agenda items. The Brown Act provides safe harbor language for the various types of permissible closed sessions.¹² Substantial compliance with the safe harbor language is recommended to protect legislative bodies and elected officials from legal challenges.

Mailed agenda upon written request

The legislative body, or its designee, must mail a copy of the agenda or, if requested, the entire agenda packet, to any person who has filed a written request for such materials. These copies shall be mailed at the time the agenda is posted or upon distribution to all, or a majority of all, of the members of the legislative body, whichever occurs first. If the local agency has an internet website, this requirement can be satisfied by emailing a copy of, or website link to, the agenda or agenda packet if the person making the request asks for it to be emailed. Further, if requested, these materials must be made available in appropriate alternative formats to persons with disabilities.

A request for notice is valid for one calendar year and renewal requests must be filed following January 1 of each year. The legislative body may establish a fee to recover the cost of providing the service. Failure of the requesting person to receive the agenda does not constitute grounds for invalidation of actions taken at the meeting.¹³



Notice requirements for special meetings

There is no express agenda requirement for special meetings, but the notice of the special meeting effectively serves as the agenda and limits the business that may be transacted or discussed. Written notice must be sent to each member of the legislative body (unless waived in writing by that member) and to each local newspaper of general circulation and each radio and television station that has requested such notice in writing. This notice must be delivered at least 24 hours before the time of the meeting by personal delivery or any other means that ensures receipt.

The notice must state the time and place of the meeting as well as all business to be transacted or discussed. It is recommended that the business to be transacted or discussed be described in the same manner that an item for a regular meeting would be described on the agenda, that is, with a brief general description. Some items must appear on a regular, not special, meeting agenda (e.g., general law city adoption of an ordinance or consideration of local agency executive compensation).¹⁴

As noted above, closed session items should be described in accordance with the Brown Act's safe harbor provisions to protect legislative bodies and elected officials from challenges of noncompliance with notice requirements.

The special meeting notice must also be posted at least 24 hours prior to the special meeting using the same methods as posting an agenda for a regular meeting: at a site that is freely accessible to the public, and on the agency's website if (1) the local agency has a website and (2) the legislative body whose meeting is the subject of the agenda is either (a) a governing body or (b) has members that are compensated, with one or more

members that are also members of a governing body.¹⁵

Notices and agendas for adjourned and continued meetings and hearings

A regular or special meeting can be adjourned and re-adjourned to a time and place specified in the order of adjournment.¹⁶ If no time is stated, the meeting is continued to the hour for regular meetings. Whoever is present (even if they are less than a quorum) may so adjourn a meeting; if no member of the legislative body is present, the clerk or secretary may adjourn the meeting. If a meeting is adjourned for less than five calendar days, no new agenda need be posted so long as a new item of business is not introduced.¹⁷ A copy of the order of adjournment must be posted within 24 hours after the adjournment, at or near the door of the place where the meeting was held.

A hearing can be continued to a subsequent meeting. The process is the same as for continuing adjourned meetings, except that if the hearing is continued to a time less than 24 hours away, a copy of the order or notice of continuance must be posted immediately following the meeting.¹⁸

Notice requirements for emergency meetings

The special meeting notice provisions apply to emergency meetings, except for the 24-hour notice.¹⁹ News media that have requested written notice of special meetings must be notified by telephone at least one hour in advance of an emergency meeting, and all telephone numbers provided in that written request must be tried. If telephones are not working, the notice requirements are deemed waived. However, the news media must be notified as soon as possible of the meeting and any action taken.

News media may make a practice of having written requests on file for notification of special or emergency meetings. Absent such a request, a local agency has no legal obligation to notify news media of special or emergency meetings — although notification may be advisable in any event to avoid controversy.

Notice of compensation for simultaneous or serial meetings

A legislative body that has convened a meeting and whose membership constitutes a quorum of another legislative body, may convene a simultaneous or serial meeting of the other legislative body only after a clerk or member of the convened legislative body orally announces (1) the amount of compensation or stipend, if any, that each member will be entitled to receive as a result of convening the meeting of the other legislative body; and (2) that the compensation or stipend is provided as a result of convening the meeting of that body.²⁰

No oral disclosure of the amount of the compensation is required if the entire amount of such compensation is prescribed by statute and no additional compensation has been authorized by the local agency. Further, no disclosure is required with respect to reimbursements for actual and necessary expenses incurred in the performance of the member's official duties, such as for travel, meals, and lodging.

Educational agency meetings

The Education Code contains some special agenda and special meeting provisions.²¹ However, they are generally consistent with the Brown Act. An item is probably void if not posted.²² A school district board must also adopt regulations to make sure the public can place matters affecting the district's business on meeting agendas and can address the board on those items.²³

Notice requirements for tax or assessment meetings and hearings

The Brown Act prescribes specific procedures for adoption by a city, county, special district, or joint powers authority of any new or increased tax or assessment imposed on businesses.²⁴ Although written broadly, these Brown Act provisions do not apply to new or increased real property taxes or assessments, as those are governed by the California Constitution, Article XIII C or XIII D, enacted by Proposition 218. At least one public meeting must be held to allow public testimony on the tax or assessment. In addition, there must also be at least 45 days notice of a public hearing at which the legislative body proposes to enact or increase the tax or assessment. Notice of the public meeting and public hearing must be provided at the same time and in the same document. The public notice relating to general taxes must be provided by newspaper publication. The public notice relating to new or increased business assessments must be provided through a



mailing to all business owners proposed to be subject to the new or increased assessment. The agency may recover the reasonable costs of the public meetings, hearings, and notice.

The Brown Act exempts certain fees, standby or availability charges, recurring assessments, and new or increased assessments that are subject to the notice and hearing requirements of the Constitution.²⁵ As a practical matter, the Constitution's notice requirements have preempted this section of the Brown Act.

Non-agenda items

The Brown Act generally prohibits any action or discussion of items not on the posted agenda. However, there are three specific situations in which a legislative body can act on an item not on the agenda:²⁶

- When a majority decides there is an “emergency situation” (as defined for emergency meetings).
- When two-thirds of the members present (or all members if less than two-thirds are present) determine there is a need for immediate action, and the need to take action “came to the attention of the local agency subsequent to the agenda being posted.” This exception requires a degree of urgency. Further, an item cannot be considered under this provision if the legislative body or the staff knew about the need to take immediate action before the agenda was posted. A new need does not arise because staff forgot to put an item on the agenda or because an applicant missed a deadline.
- When an item appeared on the agenda of, and was continued from, a meeting held not more than five days earlier.

The exceptions are narrow, as indicated by this list. The first two require a specific determination by the legislative body. That determination can be challenged in court and, if unsubstantiated, can lead to invalidation of an action.

“I’d like a two-thirds vote of the board so we can go ahead and authorize commencement of phase two of the East Area Project,” said Chair Lopez.

“It’s not on the agenda. But we learned two days ago that we finished phase one ahead of schedule — believe it or not — and I’d like to keep it that way. Do I hear a motion?”

The desire to stay ahead of schedule generally would not satisfy “a need for immediate action.” Too casual an action could invite a court challenge by a disgruntled resident. The prudent course is to place an item on the agenda for the next meeting and not risk invalidation.

“We learned this morning of an opportunity for a state grant,” said the chief engineer at the regular board meeting, “but our application has to be submitted in two days. We’d like the board to give us the go-ahead tonight, even though it’s not on the agenda.”

A legitimate immediate need can be acted upon even though not on the posted agenda by following a two-step process:

PRACTICE TIP: Subject to very limited exceptions, the Brown Act prohibits any action or discussion of an item not on the posted agenda.

- First, make two determinations: (1) that there is an immediate need to take action and (2) that the need arose after the posting of the agenda. The matter is then placed on the agenda.
- Second, discuss and act on the added agenda item.

Responding to the public

The public can talk about anything within the jurisdiction of the legislative body, but the legislative body generally cannot act on or discuss an item not on the agenda. What happens when a member of the public raises a subject not on the agenda?

While the Brown Act does not allow discussion or action on items not on the agenda, it does allow members of the legislative body, or its staff, to “briefly respond” to comments or questions from members of the public, provide a reference to staff or other resources for factual information, or direct staff to place the issue on a future agenda. In addition, even without a comment from the public, a legislative body member or a staff member may ask for information, request a report back, request to place a matter on the agenda for a subsequent meeting (subject to the body’s rules or procedures), ask a question for clarification, make a brief announcement, or briefly report on their own activities.²⁷ However, caution should be used to avoid any discussion or action on such items.



Council Member Jefferson: I would like staff to respond to Resident Joe’s complaints during public comment about the repaving project on Elm Street. Are there problems with this project?

City Manager Frank: The public works director has prepared a 45-minute PowerPoint presentation for you on the status of this project and will give it right now.

Council Member Brown: Take all the time you need; we need to get to the bottom of this. Our residents are unhappy.

It is clear from this dialogue that the Elm Street project was not on the council’s agenda but was raised during the public comment period for items not on the agenda. Council Member Jefferson properly asked staff to respond; the city manager should have given at most a brief response. If a lengthy report from the public works director was warranted, the city manager should have stated that it would be placed on the agenda for the next meeting. Otherwise, both the long report and the likely discussion afterward will improperly embroil the council in a matter that is not listed on the agenda.

The right to attend and observe meetings

A number of Brown Act provisions protect the public's right to attend, observe, and participate in meetings.

Members of the public cannot be required to register their names, provide other information, complete a questionnaire, or otherwise "fulfill any condition precedent" to attending a meeting. Any attendance list, questionnaire, or similar document posted at or near the entrance to the meeting room or circulated at a meeting must clearly state that its completion is voluntary and that all persons may attend whether or not they fill it out.²⁸

No meeting can be held in a facility that prohibits attendance based on race, religion, color, national origin, ethnic group identification, age, sex, sexual orientation, or disability, or that is inaccessible to the disabled. Nor can a meeting be held where the public must make a payment or purchase in order to be present.²⁹ This does not mean, however, that the public is entitled to free entry to a conference attended by a majority of the legislative body.³⁰

While a legislative body may use teleconferencing in connection with a meeting, the public must be given notice of and access to the teleconference location. Members of the public must be able to address the legislative body from the teleconference location.³¹

Action by secret ballot, whether preliminary or final, is flatly prohibited.³²

All actions taken by the legislative body in open session, and the vote of each member thereon, must be disclosed to the public at the time the action is taken.³³

Q. The agenda calls for election of the legislative body's officers. Members of the legislative body want to cast unsigned written ballots that would be tallied by the clerk, who would announce the results. Is this voting process permissible?

A. *No. The possibility that a public vote might cause hurt feelings among members of the legislative body or might be awkward — or even counterproductive — does not justify a secret ballot.*

The legislative body may remove persons from a meeting who willfully interrupt or disrupt proceedings.³⁴ Ejection is justified only when audience members actually disrupt the proceedings,³⁵ or, alternatively, if the presiding member of the legislative body warns a person that their behavior is disruptive and that continued disruption may result in their removal (but no prior warning is required if there is a use of force or true threat of force).³⁶ If order cannot be restored after ejecting disruptive persons, the meeting room may be cleared. Members of the news media who have not participated in the disturbance must be allowed to continue to attend the meeting. The legislative body may establish a procedure to readmit an individual or individuals not responsible for the disturbance.³⁷

Records and recordings

The public has the right to review agendas and other writings distributed by any person to a majority of the legislative body in connection with a matter subject to discussion or consideration at a meeting. Except for privileged documents, those materials are public records and must be made available upon request without delay.³⁸ A fee or deposit as permitted by the California Public Records Act may be charged for a copy of a public record.³⁹

- Q.** In connection with an upcoming hearing on a discretionary use permit, counsel for the legislative body transmits a memorandum to all members of the body outlining the litigation risks in granting or denying the permit. Must this memorandum be included in the packet of agenda materials available to the public?
- A.** *No. The memorandum is a privileged attorney-client communication.*
- Q.** In connection with an agenda item calling for the legislative body to approve a contract, staff submits to all members of the body a financial analysis explaining why the terms of the contract favor the local agency. Must this memorandum be included in the packet of agenda materials available to the public?
- A.** *Yes. The memorandum has been distributed to the majority of the legislative body, relates to the subject matter of a meeting, and is not a privileged communication.*

A legislative body may discuss or act on some matters without considering written materials. But if writings are distributed to a majority of a legislative body in connection with an agenda item, they must also be available to the public. A nonexempt or otherwise non-privileged writing distributed to a majority of the legislative body less than 72 hours before the meeting must be made available for inspection at the time of distribution at a public office or location designated for that purpose, and the agendas for all meetings of the legislative body must include the address of this office or location.⁴⁰ The location designated for public inspection must be open to the public, not a locked or closed office. Alternatively, the documents can be posted on the city's website for public review if statutory requirements are met.⁴¹

A writing distributed during a meeting must be made public:

- At the meeting if prepared by the local agency or a member of its legislative body.
- After the meeting if prepared by some other person.⁴²

This requirement does not prevent assessing a fee or deposit for providing a copy of a public record pursuant to the California Public Records Act except where required to accommodate persons with disabilities.⁴³

Any tape or film record of an open and public meeting made for whatever purpose by or at the direction of the local agency is subject to the California Public Records Act; however, it may be erased or destroyed 30 days after the taping or recording. Any inspection of a video or tape recording is to be provided without charge on a video or tape player made available by the local agency.⁴⁴ The agency may impose its ordinary charge for copies that is consistent with the California Public Records Act.⁴⁵

In addition, the public is specifically allowed to use audio or videotape recorders or still or motion picture cameras at a meeting to record meetings of legislative bodies, absent a reasonable finding by the body that noise, illumination, or obstruction of view caused by recorders or cameras would persistently disrupt the proceedings.⁴⁶

PRACTICE TIP: Public speakers cannot be compelled to give their name or address as a condition of speaking. The clerk or presiding officer may request speakers to complete a speaker card or identify themselves for the record but must respect a speaker's desire for anonymity.

Similarly, a legislative body cannot prohibit or restrict the public broadcast of its open and public meetings without making a reasonable finding that the noise, illumination, or obstruction of view would persistently disrupt the proceedings.⁴⁷

The public's right to speak during a meeting

Every agenda for a regular meeting must allow members of the public to speak on any item of interest, as long as the item is within the subject matter jurisdiction of the legislative body. Further, the public must be allowed to speak on a specific item of business before or during the legislative body's consideration of it.⁴⁸

- Q.** Must the legislative body allow members of the public to show videos or make a PowerPoint presentation during the public comment part of the agenda, as long as the subject matter is relevant to the agency and is within the established time limit?
- A.** *Probably, although the agency is under no obligation to provide equipment.*

Moreover, the Brown Act, as well as case law, prevents legislative bodies from prohibiting public criticism of policies, procedures, programs, or services of the agency or the acts or omissions of the legislative body itself.⁴⁹ However, this prohibition does not provide immunity for defamatory statements.⁵⁰

- Q.** May the presiding officer prohibit a member of the audience from publicly criticizing an agency employee by name during public comments?
- A.** *No, as long as the criticism pertains to job performance.*
- Q.** During the public comment period of a regular meeting of the legislative body, a resident urges the public to support and vote for a candidate vying for election to the body. May the presiding officer gavel the speaker out of order for engaging in political campaign speech?
- A.** *There is no case law on this subject. Some would argue that purely campaign issues are outside the subject matter jurisdiction of the body within the meaning of Section 54954.3(a). Others take the view that the speech must be allowed under paragraph (c) of that section where relevant to the governing of the agency and an implicit criticism of the incumbents' performance of city business.*

The legislative body may adopt reasonable regulations, including a limit on the total time permitted for public comment and a limit on the time permitted per speaker.⁵¹ Such regulations should be enforced fairly and without regard to speakers' viewpoints. The legislative body has discretion to modify its regulations regarding time limits on public comment if necessary. For example, the time limit could be shortened to accommodate a lengthy agenda or lengthened to allow additional time for discussion on a complicated matter.⁵²

The public does not need to be given an opportunity to speak on an item that has already been considered by a committee made up exclusively of members of the legislative body at a regular (but not special) public meeting if all interested members of the public had the opportunity to

speak on the item before or during its consideration, and if the item has not been substantially changed.⁵³

Notices and agendas for special meetings must also give members of the public the opportunity to speak before or during consideration of an item on the agenda but need not allow members of the public an opportunity to speak on other matters within the jurisdiction of the legislative body.⁵⁴

ENDNOTES

- 1 Cal. Gov. Code, § 54954.2, subd. (a)(1).
- 2 78 Ops.Cal.Atty.Gen. 327 (1995).
- 3 88 Ops.Cal.Atty.Gen. 218 (2005).
- 4 Cal. Gov. Code, §§ 54954.2, subd. (a)(1) and 54954.2, subd. (d).
- 5 Cal. Gov. Code, § 54960.1, subd. (d)(1).
- 6 99 Ops.Cal.Atty.Gen. 11 (2016).
- 7 *North Pacifica LLC v. California Coastal Commission* (2008) 166 Cal.App.4th 1416, 1432.
- 8 99 Ops.Cal.Atty.Gen. 11 (2016).
- 9 Cal. Gov. Code, § 54954.2, subd. (a)(1).
- 10 *San Joaquin Raptor Rescue v. County of Merced* (2013) 216 Cal.App.4th 1167 (legislative body's approval of California Environmental Quality Act [CEQA] action [mitigated negative declaration] without specifically listing it on the agenda violates the Brown Act, even if the agenda generally describes the development project that is the subject of the CEQA analysis). See also *GI Industries v. City of Thousand Oaks* (2022) 84 Cal.App.5th 814 (depublished) (Brown Act requires CEQA finding of exemption to be listed on agenda items that are projects under CEQA).
- 11 *Hernandez v. Town of Apple Valley* (2017) 7 Cal.App.5th 194.
- 12 Cal. Gov. Code, § 54954.5.
- 13 Cal. Gov. Code, § 54954.1.
- 14 Cal. Gov. Code, §§ 36934; 54956, subd. (b).
- 15 Cal. Gov. Code, § 54956, subds. (a) and (c).
- 16 Cal. Gov. Code, § 54955.
- 17 Cal. Gov. Code, § 54954.2, subd. (b)(3).
- 18 Cal. Gov. Code, § 54955.1.
- 19 Cal. Gov. Code, § 54956.5.
- 20 Cal. Gov. Code, § 54952.3.
- 21 Cal. Edu. Code, §§ 35144, 35145, and 72129.
- 22 *Carlson v. Paradise Unified School District* (1971) 18 Cal.App.3d 196.
- 23 Cal. Edu. Code, § 35145.5
- 24 Cal. Edu. Code, § 54954.6
- 25 See Cal. Const. Art. XIII C, XIII D; Cal. Gov. Code, § 54954.6, subd. (h).
- 26 Cal. Gov. Code, § 54954.2, subd. (b).
- 27 Cal. Gov. Code, § 54954.2, subd. (a)(2); *Cruz v. City of Culver City* (2016) 2 Cal.App.5th 239 (six-minute colloquy on non-agenda item with staff answering questions and advising that matter could be placed on future agenda fell within exceptions to discussing or acting upon non-agenda items).



- 28 Cal. Gov. Code, § 54953.3.
- 29 Cal. Gov. Code, § 54961, subd. (a); Cal. Gov. Code, § 11135, subd. (a).
- 30 Cal. Gov. Code, § 54952.2, subd. (c)(2).
- 31 Cal. Gov. Code, § 54953, subd. (b).
- 32 Cal. Gov. Code, § 54953, subd. (c).
- 33 Cal. Gov. Code, § 54953, subd. (c)(2).
- 34 Cal. Gov. Code, §§ 54957.9, 54957.95.
- 35 *Norse v. City of Santa Cruz* (9th Cir. 2010) 629 F.3d 966 (silent and momentary Nazi salute directed toward mayor is not a disruption); *Acosta v. City of Costa Mesa* (9th Cir. 2013) 718 F.3d 800 (city council may not prohibit “insolent” remarks by members of the public absent actual disruption); but see *Kirkland v. Luken* (S.D. Ohio 2008) 536 F.Supp.2d 857 (finding no First Amendment violation by mayor for turning off microphone and removing speaker who used foul and inflammatory language that was deemed as “likely to incite the members of the audience during the meeting, cause disorder, and disrupt the meeting”).
- 36 Cal. Gov. Code, § 54957.95.
- 37 Cal. Gov. Code, § 54957.9.
- 38 Cal. Gov. Code, § 54957.5.
- 39 Cal. Gov. Code, § 54957.5, subd. (d).
- 40 Cal. Gov. Code, § 54957.5(b); see also *Sierra Watch v. Placer County* (2021) 69 Cal.App.5th 1.
- 41 Cal. Gov. Code § 54957.5.
- 42 Cal. Gov. Code, § 54957.5, subd. (c).
- 43 Cal. Gov. Code, § 54957.5, subd. (d).
- 44 Cal. Gov. Code, § 54953.5, subd. (b).
- 45 Cal. Gov. Code, § 54957.5, subd. (d).
- 46 Cal. Gov. Code, § 54953.5, subd. (a).
- 47 Cal. Gov. Code, § 54953.6.
- 48 Cal. Gov. Code, § 54954.3, subd. (a).
- 49 Cal. Gov. Code, § 54954.3, subd. (c); *Acosta v. City of Costa Mesa* (9th Cir. 2013) 718 F.3d 800.
- 50 Cal. Gov. Code, § 54954.3, subd. (c).
- 51 *Ribakoff v. City of Long Beach* (2018) 27 Cal.App.5th 150 (public comment time limit of three minutes for each speaker did not violate First Amendment).
- 52 Cal. Gov. Code, § 54954.3, subd. (b); *Chaffee v. San Francisco Public Library Commission* (2005) 134 Cal.App.4th 109; 75 Ops.Cal.Atty.Gen. 89 (1992).
- 53 Cal. Gov. Code, § 54954.3, subd. (a); *Preven v. City of Los Angeles* (2019) 32 Cal.App.5th 925.
- 54 Cal. Gov. Code, § 54954.3, subd. (a).



Chapter 5

CLOSED SESSIONS

Agendas and reports.....	42
Litigation.....	43
Real estate negotiations	45
Public employment	46
Labor negotiations	47
Labor negotiations — school and community college districts.....	48
Other Education Code exceptions.....	48
Joint powers authorities	48
License applicants with criminal records	49
Public security.....	49
Multijurisdictional law enforcement agency	49
Hospital peer review and trade secrets	49
Other legislative bases for closed session	50
Who may attend closed sessions	50
The confidentiality of closed session discussions.....	51

Chapter 5

CLOSED SESSIONS

A closed session is a meeting of a legislative body conducted in private without the attendance of the public or press. A legislative body is authorized to meet in closed session only to the extent expressly authorized by the Brown Act.¹



As summarized in chapter 1 of this guide, it is clear that the Brown Act must be interpreted liberally in favor of open meetings, and exceptions that limit public access (including the exceptions for closed session meetings) must be narrowly construed.² The most common purposes of the closed session provisions in the Brown Act are to avoid revealing confidential information (e.g., prejudicing the city's position in litigation or compromising the privacy interests of employees). Closed sessions should be conducted keeping those narrow purposes in mind. It is not enough that a subject is sensitive, embarrassing, or controversial. Without specific authority in the Brown Act for a closed session, a matter to be considered by a legislative body must be discussed in public. However, there is no prohibition in putting overlapping exceptions on an agenda in order to provide an opportunity for more robust closed session discussions. As an example, a city council cannot give direction to the city manager about a property

negotiation during a performance evaluation exception. However, if both real property negotiation and performance evaluation exceptions are on the agenda, those discussions might be conducted. Similarly, a board of police commissioners cannot meet in closed session to provide general policy guidance to a police chief, even though some matters are sensitive and the commission considers their disclosure contrary to the public interest.³

In this chapter, the grounds for convening a closed session are called "exceptions" because they are exceptions to the general rule that meetings must be conducted openly. In some circumstances, none of the closed session exceptions applies to an issue or information the legislative body wishes to discuss privately. In these cases, it is not proper to convene a closed session, even to protect confidential information. For example, although the Brown Act does authorize closed sessions related to specified types of contracts (e.g., specified provisions of real property agreements, employee labor agreements, and litigation settlement agreements),⁴ the Brown Act does not authorize closed sessions for other contract negotiations.

Agendas and reports

Closed session items must be briefly described on the posted agenda, and the description must state the specific statutory exemption.⁵ An item that appears on the open meeting portion of the agenda may not be taken into closed session until it has been properly put on the agenda as a

PRACTICE TIP: Some problems over closed sessions arise because secrecy itself breeds distrust. The Brown Act does not require closed sessions and legislative bodies may do well to resist the tendency to call a closed session simply because it may be permitted. A better practice is to go into closed session only when necessary.

closed session item or unless it is properly added as a closed-session item by a two-thirds vote of the body after making the appropriate urgency findings.⁶

The Brown Act supplies a series of fill-in-the-blank sample agenda descriptions for various types of authorized closed sessions that provide a “safe harbor” from legal attacks. These sample agenda descriptions cover license and permit determinations, real property negotiations, existing or anticipated litigation, liability claims, threats to security, public employee appointments, evaluations and discipline, labor negotiations, multijurisdictional law enforcement cases, hospital boards of directors, medical quality assurance committees, joint powers agencies, and audits by the California State Auditor’s Office.⁷

If the legislative body intends to convene in closed session, it must include the section of the Brown Act authorizing the closed session in advance on the agenda, and it must make a public announcement prior to the closed session discussion. In most cases, the announcement may simply be a reference to the agenda item.⁸ The legislative body must take public comment on the closed session item before convening in a closed session.

Following a closed session, the legislative body must provide an oral or written report on certain actions taken and the vote of every elected member present. The timing and content of the report vary according to the reason for the closed session and the action taken.⁹ The announcements may be made at the site of the closed session, as long as the public is allowed to be present to hear them.

If there is a standing or written request for documentation, any copies of contracts, settlement agreements, or other documents finally approved or adopted in closed session must be provided to the requestor(s) after the closed session if final approval of such documents does not rest with any other party to the contract or settlement. If substantive amendments to a contract or settlement agreement approved by all parties requires retyping, such documents may be held until retyping is completed during normal business hours, but the substance of the changes must be summarized for any person inquiring about them.¹⁰

The Brown Act does not require minutes, including minutes of closed sessions. However, a legislative body may adopt an ordinance or resolution to authorize a confidential “minute book” be kept to record actions taken at closed sessions.¹¹ If one is kept, it must be made available to members of the legislative body, provided that the member asking to review minutes of a particular meeting was not disqualified from attending the meeting due to a conflict of interest.¹² A court may order the disclosure of minute books for the court’s review if a lawsuit makes sufficient claims of an open meeting violation.

Litigation

The Brown Act expressly authorizes closed sessions to discuss what is considered pending litigation.¹³ The rules that apply to holding a litigation closed session involve complex, technical definitions and procedures. Essentially, a closed session can be held by the body to confer with, or receive advice from, its legal counsel when open discussion would prejudice the position of the local agency in litigation in which the agency is, or could become, a party.¹⁴ The litigation exception under the Brown Act is narrowly construed and does not permit activities beyond a legislative body’s conferring with its own legal counsel and required support staff.¹⁵ For example, it is not permissible to hold a closed session in which settlement negotiations take place between a legislative body, a representative of an adverse party, and a mediator.¹⁶

PRACTICE TIP: Pay close attention to closed session agenda descriptions. Using the wrong label can lead to invalidation of an action taken in closed session if not substantially compliant.

The California Attorney General has opined that if the agency's attorney is not a participant, a litigation closed session cannot be held.¹⁷ In any event, local agency officials should always consult the agency's attorney before placing this type of closed session on the agenda in order to be certain that it is being done properly.

Before holding a closed session under the pending litigation exception, the legislative body must publicly state the basis for the closed session by identifying one of the following three types of matters: existing litigation, anticipated exposure to litigation, or anticipated initiation of litigation.¹⁸

Existing litigation

- Q.** May the legislative body agree to settle a lawsuit in a properly noticed closed session without placing the settlement agreement on an open session agenda for public approval?
- A.** *Yes, but the settlement agreement is a public document and must be disclosed on request. Furthermore, a settlement agreement cannot commit the agency to matters that are required to have public hearings.*¹⁹

Existing litigation includes any adjudicatory proceedings before a court, administrative body exercising its adjudicatory authority, hearing officer, or arbitrator. The clearest situation in which a closed session is authorized is when the local agency meets with its legal counsel to discuss a pending matter that has been filed in a court or with an administrative agency and names the local

agency as a party. The legislative body may meet under these circumstances to receive updates on the case from attorneys, participate in developing strategy as the case develops, or consider alternatives for resolution of the case. Generally, an agreement to settle litigation may be approved in closed session. However, an agreement to settle litigation cannot be approved in closed session if it commits the city to take an action that is required to have a public hearing.²⁰

Anticipated exposure to litigation against the local agency

Closed sessions are authorized for legal counsel to inform the legislative body of a significant exposure to litigation against the local agency, but only if based on "existing facts and circumstances" as defined by the Brown Act.²¹ The legislative body may also meet under this exception to determine whether a closed session is authorized based on information provided by legal counsel or staff. In general, the "existing facts and

circumstances" must be publicly disclosed unless they are privileged written communications or not yet known to a potential plaintiff. If an agency receives a documented threat of litigation, and intends to discuss that matter in closed session, the record of a litigation threat must be included in the body's agenda packet.²²



Anticipated initiation of litigation by the local agency

A closed session may be held under the exception for the anticipated initiation of litigation when the legislative body seeks legal advice on whether to protect the agency's rights and interests by initiating litigation.

Certain actions must be reported in open session at the same meeting following the closed session. Other actions, such as when final approval rests with another party or the court, may be announced when they become final and upon inquiry of any person.²³ Each agency attorney should be aware of and make the disclosures that are required by the particular circumstances.

Real estate negotiations

A legislative body may meet in closed session with its negotiator to discuss the purchase, sale, exchange, or lease of real property by or for the local agency. A "lease" includes a lease renewal or renegotiation. The purpose is to grant authority to the legislative body's negotiator on price and terms of payment.²⁴ Caution should be exercised to limit discussion to price and terms of payment without straying to other related issues, such as site design, architecture, or other aspects of the project for which the transaction is contemplated.²⁵

Q. May other terms of a real estate transaction, aside from price and terms of payment, be addressed in closed session?

A. *No. However, there are differing opinions over the scope of the phrase "price and terms of payment" in connection with real estate closed sessions. Many agency attorneys argue that any term that directly affects the economic value of the transaction falls within the ambit of "price and terms of payment." Others take a narrower, more literal view of the phrase.*

The agency's negotiator may be a member of the legislative body itself. Prior to the closed session, or on the agenda, the legislative body must identify its negotiators, the real property that the negotiations may concern,²⁶ and the names of the parties with whom its negotiator may negotiate.²⁷

After real estate negotiations are concluded, the approval and substance of the agreement must be publicly reported. If its own approval makes the agreement final, the body must report in open session at the public meeting during which the closed session is held. If final approval rests with another party, the local agency must report the approval and the substance of the agreement upon inquiry by any person as soon as the agency is informed of it.²⁸

"Our population is exploding, and we have to think about new school sites," said Board Member Jefferson.

"Not only that," interjected Board Member Tanaka, "we need to get rid of a couple of our older facilities."

"Well, obviously the place to do that is in a closed session," said Board Member O'Reilly. "Otherwise we're going to set off land speculation. And if we even mention closing a school, parents are going to be in an uproar."

A closed session to discuss potential sites is not authorized by the Brown Act. The exception is limited to meeting with its negotiator over specific sites — which must be identified at an open and public meeting.

PRACTICE TIP: Discussions of who to appoint to an advisory body and whether or not to censure a fellow member of the legislative body must be held in the open.

Public employment

The Brown Act authorizes a closed session “to consider the appointment, employment, evaluation of performance, discipline, or dismissal of a public employee or to hear complaints or charges brought against the employee.”²⁹ The purpose of this exception — commonly referred to as the “personnel exception” — is to avoid undue publicity or embarrassment for an employee or applicant for employment and to allow full and candid discussion by the legislative body; thus, it is restricted to discussing individuals, not general personnel policies.³⁰ The body must possess the power to appoint, evaluate, or dismiss the employee to hold a closed session under this exception.³¹ That authority may be delegated to a subsidiary appointed body.³²

An employee must be given at least 24 hours’ notice of any closed session convened to hear specific complaints or charges against them. This occurs when the legislative body is reviewing evidence, which could include live testimony, and adjudicating conflicting testimony offered as evidence. A legislative body may examine (or exclude) witnesses,³³ and the California Attorney General has opined that, when an affected employee and advocate have an official or essential role to play, they may be permitted to participate in the closed session.³⁴ The employee has the right to have the specific complaints and charges discussed in a public session rather than closed session.³⁵ If the employee is not given the 24-hour prior notice, any disciplinary action is null and void.³⁶

However, an employee is not entitled to notice and a hearing where the purpose of the closed session is to consider a performance evaluation. The Attorney General and the courts have determined that personnel performance evaluations do not constitute complaints and charges, which are more akin to accusations made against a person.³⁷

- Q.** Must 24 hours’ notice be given to an employee whose negative performance evaluation is to be considered by the legislative body in closed session?
- A.** *No, the notice is reserved for situations where the body is to hear complaints and charges from witnesses.*

Correct labeling of the closed session on the agenda is critical. A closed session agenda that identified discussion of an employment contract was not sufficient to allow dismissal of an employee.³⁸ An incorrect agenda description can result in invalidation of an action and much embarrassment.

For purposes of the personnel exception, “employee” specifically includes an officer or an independent contractor who functions as an officer or an employee. Examples of the former include a city manager, district general manager, or superintendent. Examples of the latter include a legal counsel or engineer hired on contract to act as local agency attorney or chief engineer.

Elected officials, appointees to the governing body or subsidiary bodies, and independent contractors other than those discussed above are not employees for purposes of the personnel exception.³⁹ Action on individuals who are not “employees” must also be public — including discussing and voting on appointees to committees, debating the merits of independent contractors, or considering a complaint against a member of the legislative body itself.

The personnel exception specifically prohibits discussion or action on proposed compensation in closed session except for a disciplinary reduction in pay. That means, among other things, there can be no personnel closed sessions on a salary change (other than a disciplinary reduction) between any unrepresented individual and the legislative body. However, a legislative body may address the compensation of an unrepresented individual, such as a city manager, in a closed session as part of a labor negotiation (discussed later in this chapter), yet another example of the importance of using correct agenda descriptions.

Reclassification of a job must be public, but an employee’s ability to fill that job may be considered in closed session.

Any closed session action to appoint, employ, dismiss, accept the resignation of, or otherwise affect the employment status of a public employee must be reported at the public meeting during which the closed session is held. That report must identify the title of the position, but not the names of all persons considered for an employment position.⁴⁰ However, a report on a dismissal or non-renewal of an employment contract must be deferred until administrative remedies, if any, are exhausted.⁴¹

“I have some important news to announce,” said Mayor Garcia. “We’ve decided to terminate the contract of the city manager effective immediately. The council has met in closed session, and we’ve negotiated six months’ severance pay.”

“Unfortunately, that has some serious budget consequences, so we’ve had to delay phase two of the East Area Project.”

This may be an improper use of the personnel closed session if the council agenda described the item as the city manager’s evaluation. In addition, other than labor negotiations, any action on individual compensation must be taken in open session. Caution must be exercised not to discuss in closed session issues, such as budget impacts in this hypothetical, beyond the scope of the posted closed session notice.

Labor negotiations

The Brown Act allows closed sessions for some aspects of labor negotiations. Different provisions (discussed below) apply to school and community college districts.

A legislative body may meet in closed session to instruct its bargaining representatives, which may be one or more of its members,⁴² on employee salaries and fringe benefits for both represented (“union”) and unrepresented employees. For represented employees, it may also consider working conditions that by law require negotiation. For the purpose of labor negotiation closed sessions, an “employee” includes an officer or an independent contractor who functions as an officer or an employee, but independent contractors who do not serve in the capacity of an officer or employee are not covered by this closed session exception.⁴³

PRACTICE TIP: The personnel exception specifically prohibits discussion or action on proposed compensation in closed session except for a disciplinary reduction in pay.

PRACTICE TIP: Prior to the closed session, the legislative body must hold an open and public session in which it identifies its designated representatives.

These closed sessions may take place before or during negotiations with employee representatives. Prior to the closed session, the legislative body must hold an open and public session in which it identifies its designated representatives.

During its discussions with representatives on salaries and fringe benefits, the legislative body may discuss available funds and funding priorities, but only to instruct its representative. The body may also meet in closed session with a conciliator who has intervened in negotiations.⁴⁴

The approval of an agreement concluding labor negotiations with represented employees must be reported after the agreement is final and has been accepted or ratified by the other party. The report must identify the item approved and the other party or parties to the negotiation.⁴⁵ The labor closed sessions specifically cannot include final action on proposed compensation of one or more unrepresented employees.

Labor negotiations – school and community college districts

Employee relations for school districts and community college districts are governed by the Rodda Act, where different meeting and special notice provisions apply. The entire board, for example, may negotiate in closed sessions.

Four types of meetings are exempted from compliance with the Rodda Act:

1. A negotiating session with a recognized or certified employee organization.
2. A meeting of a mediator with either side.
3. A hearing or meeting held by a fact finder or arbitrator.
4. A session between the board and its bargaining agent, or the board alone, to discuss its position regarding employee working conditions and instruct its agent.⁴⁶

Public participation under the Rodda Act also takes another form.⁴⁷ All initial proposals of both sides must be presented at public meetings and are public records. The public must be given reasonable time to inform itself and to express its views before the district may adopt its initial proposal. In addition, new topics of negotiations must be made public within 24 hours. Any votes on such a topic must be followed within 24 hours by public disclosure of the vote of each member.⁴⁸ The final vote must be in public.

Other Education Code exceptions

The Education Code governs student disciplinary meetings by boards of school districts and community college districts. District boards may hold a closed session to consider the suspension or discipline of a student if a public hearing would reveal personal, disciplinary, or academic information about the student contrary to state and federal pupil privacy law. The student's parent or guardian may request an open meeting.⁴⁹

Community college districts may also hold closed sessions to discuss some student disciplinary matters, awarding of honorary degrees, or gifts from donors who prefer to remain anonymous.⁵⁰ Kindergarten through 12th grade districts may also meet in closed session to review the contents of the statewide assessment instrument.⁵¹

PRACTICE TIP: Attendance by the entire legislative body before a grand jury would not constitute a closed session meeting under the Brown Act.

Joint powers authorities

The legislative body of a joint powers authority may adopt a policy regarding limitations on disclosure of confidential information obtained in closed session, and may meet in closed session to discuss information that is subject to the policy.⁵²

License applicants with criminal records

A closed session is permitted when an applicant who has a criminal record applies for a license or license renewal and the legislative body wishes to discuss whether the applicant is sufficiently rehabilitated to receive the license. The applicant and the applicant's attorney are authorized to attend the closed session meeting. If the body decides to deny the license, the applicant may withdraw the application. If the applicant does not withdraw it, the body must deny the license in public, either immediately or at its next meeting. No information from the closed session can be revealed without consent of the applicant, unless the applicant takes action to challenge the denial.⁵³

Public security

Legislative bodies may meet in closed session to discuss matters posing a threat to the security of public buildings; essential public services, including water, sewer, gas, or electric service; or to the public's right of access to public services or facilities over which the legislative body has jurisdiction. Closed session meetings for these purposes must be held with designated security or law enforcement officials, including the Governor, Attorney General, district attorney, agency attorney, sheriff or chief of police, or their deputies or agency security consultant or security operations manager.⁵⁴ Action taken in closed session with respect to such public security issues is not reportable action.

Multijurisdictional law enforcement agency

A joint powers agency formed to provide law enforcement services (involving drugs; gangs; sex crimes; firearms trafficking; felony possession of a firearm; high technology, computer, or identity theft; human trafficking; or vehicle theft) to multiple jurisdictions may hold closed sessions to discuss case records of an ongoing criminal investigation, to hear testimony from persons involved in the investigation, and to discuss courses of action in particular cases.⁵⁵

The exception applies to the legislative body of the joint powers agency and to any body advisory to it. The purpose is to prevent impairment of investigations, to protect witnesses and informants, and to permit discussion of effective courses of action.⁵⁶

Hospital peer review and trade secrets

Two specific kinds of closed sessions are allowed for district hospitals and municipal hospitals under other provisions of law:⁵⁷

1. A meeting to hear reports of hospital medical audit or quality assurance committees or for related deliberations. However, an applicant or medical staff member whose staff privileges are the direct subject of a hearing may request a public hearing.
2. A meeting to discuss "reports involving trade secrets" — provided no action is taken.



A “trade secret” is defined as information that is not generally known to the public or competitors and that (1) “derives independent economic value, actual or potential” by virtue of its restricted knowledge; (2) is necessary to initiate a new hospital service or program or facility; and (3) would, if prematurely disclosed, create a substantial probability of depriving the hospital of a substantial economic benefit.

The provision prohibits use of closed sessions to discuss transitions in ownership or management, or the district’s dissolution.⁵⁸

Other legislative bases for closed session

Since any closed session meeting of a legislative body must be authorized by the Legislature, it is important to review the Brown Act carefully to determine if there is a provision that authorizes a closed session for a particular subject matter. There are some less frequently

encountered topics that are authorized to be discussed by a legislative body in closed session under the Brown Act, including a response to a confidential final draft audit report from the Bureau of State Audits,⁵⁹ consideration of the purchase or sale of particular pension fund investments by a legislative body of a local agency that invests pension funds,⁶⁰ hearing a charge or complaint from a member enrolled in a health plan by a legislative body of a local agency that provides Medical services,⁶¹ discussions by a county board of supervisors that governs a health plan licensed pursuant to the Knox-Keene Health Care Services Plan Act related to trade secrets or contract negotiations concerning rates of payment,⁶² and discussions by an insurance pooling joint powers agency related to a claim filed against, or liability of, the agency or a member of the agency.⁶³

PRACTICE TIP: Meetings are either open or closed. There is nothing “in between.”⁶⁴

Who may attend closed sessions

Meetings of a legislative body are either fully open or fully closed; there is nothing in between. Therefore, local agency officials and employees must pay particular attention to the authorized attendees for the particular type of closed session. As summarized above, the authorized attendees may differ based on the topic of the closed session. Closed sessions may involve only the members of the legislative body and only agency counsel, management and support staff, and consultants necessary for consideration of the matter that is the subject of closed session, with very limited exceptions for adversaries or witnesses with official roles in particular types of hearings (e.g., personnel disciplinary hearings and license hearings). In any case, individuals who do not have an official or essential role in the closed session subject matters must be excluded from closed sessions.⁶⁵

Q. May the lawyer for someone suing the agency attend a closed session in order to explain to the legislative body why it should accept a settlement offer?

A. *No, attendance in closed sessions is reserved exclusively for the agency’s advisors.*

The confidentiality of closed session discussions

The Brown Act explicitly prohibits the unauthorized disclosure of confidential information acquired in a closed session by any person present, and offers various remedies to address breaches of confidentiality.⁶⁶ It is incumbent upon all those attending lawful closed sessions to protect the confidentiality of those discussions. One court has held that members of a legislative body cannot be compelled to divulge the content of closed session discussions through the discovery process.⁶⁷ Only the legislative body acting as a body may agree to divulge confidential closed session information. With regard to attorney-client privileged communications, the entire body is the holder of the privilege, and only the entire body can decide to waive the privilege.⁶⁸

Before adoption of the Brown Act provision specifically prohibiting disclosure of closed session communications, agency attorneys and the Attorney General long opined that officials have a fiduciary duty to protect the confidentiality of closed session discussions. The Attorney General issued an opinion that it is “improper” for officials to disclose information regarding pending litigation that was received during a closed session,⁶⁹ though the Attorney General has also concluded that a local agency is preempted from adopting an ordinance criminalizing public disclosure of closed session discussions.⁷⁰ In any event, in 2002, the Brown Act was amended to prescribe particular remedies for breaches of confidentiality. These remedies include injunctive relief and, if the breach is a willful disclosure of confidential information, disciplinary action against an employee and referral of a member of the legislative body to the grand jury.⁷¹

The duty of maintaining confidentiality, of course, must give way to the responsibility to disclose improper matters or discussions that may come up in closed sessions. In recognition of this public policy, under the Brown Act, a local agency may not penalize a disclosure of information learned during a closed session if the disclosure (1) is made in confidence to the district attorney or the grand jury due to a perceived violation of law; (2) is an expression of opinion concerning the propriety or legality of actions taken in closed session, including disclosure of the nature and extent of the illegal action; or (3) is information that is not confidential.⁷²

The interplay between these possible sanctions and an official’s First Amendment rights is complex and beyond the scope of this guide. Suffice it to say that this is a matter of great sensitivity and controversy.

“I want the press to know that I voted in closed session against filing the eminent domain action,” said Council Member Chang.

“Don’t settle too soon,” reveals Council Member Watson to the property owner, over coffee. “The city’s offer coming your way is not our bottom line.”

The first comment to the press may be appropriate if it is a part of an action taken by the city council in closed session that must be reported publicly.⁷³ The second comment to the property owner is not. Disclosure of confidential information acquired in closed session is expressly prohibited and harmful to the agency.

PRACTICE TIP: There is a strong interest in protecting the confidentiality of proper and lawful closed sessions.

ENDNOTES

- 1 Cal. Gov. Code, § 54962.
- 2 Cal. Const. , Art. 1, § 3.
- 3 61 Ops.Cal.Atty.Gen. 220 (1978); but see Cal. Gov. Code, § 54957.8 (multijurisdictional law enforcement agencies are authorized to meet in closed session to discuss the case records of ongoing criminal investigations and other related matters).
- 4 Cal. Gov. Code, § 54957.1.
- 5 Cal. Gov. Code, § 54954.5.
- 6 Cal. Gov. Code, § 54954.2.
- 7 Cal. Gov. Code, § 54954.5.
- 8 Cal. Gov. Code, §§ 54956.9, 54957.7.
- 9 Cal. Gov. Code, § 54957.1, subd. (a).
- 10 Cal. Gov. Code, § 54957.1, subd. (b).
- 11 Cal. Gov. Code, § 54957.2.
- 12 *Hamilton v. Town of Los Gatos* (1989) 213 Cal.App.3d 1050; 2 Cal. Code Regs. § 18707.
- 13 But see *Roberts v. City of Palmdale* (1993) 5 Cal.4th 363 (protection of the attorney-client privilege alone cannot by itself be the reason for a closed session).
- 14 Cal. Gov. Code, § 54956.9; *Shapiro v. Board of Directors of Center City Development Corp.* (2005) 134 Cal.App.4th 170 (agency must be a party to the litigation).
- 15 82 Ops.Cal.Atty.Gen. 29 (1999).
- 16 *Page v. Miracosta Community College District* (2009) 180 Cal.App.4th 471.
- 17 “*The Brown Act*,” California Attorney General (2003), p. 40.
- 18 Cal. Gov. Code, § 54956.9, subd. (g).
- 19 See e.g., *Avco Community Developers, Inc. v. South Coast Regional Com.* (1976) 17 Cal.3d 785; *Trancas Property Owners Assn. v. City of Malibu* (2006) 138 Cal.App.4th 172.
- 20 *Trancas Property Owners Assn. v. City of Malibu* (2006) 138 Cal.App.4th 172.
- 21 Cal. Gov. Code, § 54956.9, subd. (e).
- 22 *Fowler v. City of Lafayette* (2020) 46 Cal.App.5th 360.
- 23 Cal. Gov. Code, § 54957.1.
- 24 Cal. Gov. Code, § 54956.8.
- 25 *Shapiro v. San Diego City Council* (2002) 96 Cal.App.4th 904. See also 93 Ops.Cal.Atty.Gen. 51 (2010) (redevelopment agency may not convene a closed session to discuss rehabilitation loan for a property already subleased to a loan recipient, even if the loan incorporates some of the sublease terms and includes an operating covenant governing the property); 94 Ops.Cal.Atty.Gen. 82 (2011) (real estate closed session may address form, manner, and timing of consideration and other items that cannot be disclosed without revealing price and terms).
- 26 73 Ops.Cal.Atty.Gen. 1 (1990).
- 27 Cal. Gov. Code, §§ 54956.8, 54954.5, subd. (b).
- 28 Cal. Gov. Code, § 54957.1, subd. (a)(1).
- 29 Cal. Gov. Code, § 54957, subd. (b).
- 30 63 Ops.Cal.Atty.Gen. 153 (1980); but see *Duwall v. Board of Trustees* (2000) 93 Cal.App.4th 902 (board may discuss personnel evaluation criteria, process and other preliminary matters in closed session but only if related to the evaluation of a particular employee).

- 31 *Gillespie v. San Francisco Public Library Commission* (1998) 67 Cal.App.4th 1165; 85 Ops.Cal.Atty.Gen. 77 (2002).
- 32 *Gillespie v. San Francisco Public Library Commission* (1998) 67 Cal.App.4th 1165; 80 Ops.Cal.Atty.Gen. 308 (1997). Interviews of candidates to fill a vacant staff position conducted by a temporary committee appointed by the governing body may be done in closed session.
- 33 Cal. Gov. Code, § 54957, subd. (b)(3).
- 34 88 Ops.Cal.Atty.Gen. 16 (2005).
- 35 *Morrison v. Housing Authority of the City of Los Angeles* (2003) 107 Cal.App.4th 860.
- 36 Cal. Gov. Code, § 54957, subd. (b); but see *Bollinger v. San Diego Civil Service Commission* (1999) 71 Cal.App.4th 568 (notice not required for closed session deliberations regarding complaints or charges when there was a public evidentiary hearing prior to closed session).
- 37 78 Ops.Cal.Atty.Gen. 218 (1995); *Bell v. Vista Unified School District* (2000) 82 Cal.App.4th 672; *Furtado v. Sierra Community College* (1998) 68 Cal.App.4th 876; *Fischer v. Los Angeles Unified School District* (1999) 70 Cal.App.4th 87.
- 38 *Moreno v. City of King* (2005) 127 Cal.App.4th 17.
- 39 Cal. Gov. Code, § 54957.
- 40 *Gillespie v. San Francisco Public Library Commission* (1998) 67 Cal.App.4th 1165.
- 41 Cal. Gov. Code, § 54957.1, subd. (a)(5).
- 42 Cal. Gov. Code, § 54957.6.
- 43 Cal. Gov. Code, § 54957.6, subd. (b); see also 98 Ops.Cal.Atty.Gen. 41 (2015) (a project labor agreement between a community college district and workers hired by contractors or subcontractors is not a proper subject of closed session for labor negotiations because the workers are not “employees” of the district).
- 44 Cal. Gov. Code, § 54957.6; 51 Ops.Cal.Atty.Gen. 201 (1968).
- 45 Cal. Gov. Code, § 54957.1, subd. (a)(6).
- 46 Cal. Gov. Code, § 3549.1.
- 47 Cal. Gov. Code, § 3540.
- 48 Cal. Gov. Code, § 3547.
- 49 Cal. Edu. Code, § 48918; but see *Rim of the World Unified School District v. Superior Court* (2003) 104 Cal.App.4th 1393 (Section 48918 preempted by the Federal Family Educational Right and Privacy Act in regard to expulsion proceedings).
- 50 Cal. Edu. Code, § 72122.
- 51 Cal. Edu. Code, § 60617.
- 52 Cal. Gov. Code, § 54956.96.
- 53 Cal. Gov. Code, § 54956.7.
- 54 Cal. Gov. Code, § 54957.
- 55 *McKee v. Los Angeles Interagency Metropolitan Police Apprehension Crime Task Force* (2005) 134 Cal. App.4th 354.
- 56 Cal. Gov. Code, § 54957.8.
- 57 Cal. Gov. Code, § 54962.
- 58 Cal. Health and Saf. Code, § 32106.
- 59 Cal. Gov. Code, § 54956.75.
- 60 Cal. Gov. Code, § 54956.81.

- 61 Cal. Gov. Code, § 54956.86.
- 62 Cal. Gov. Code, § 54956.87.
- 63 Cal. Gov. Code, § 54956.95.
- 64 Ops.Cal.Atty.Gen. 34 (1965)
- 65 82 Ops.Cal.Atty.Gen. 29 (1999); 2022 WL 1814322, 105 Ops. Cal.Atty.Gen. 89 (2022).
- 66 Cal. Gov. Code, § 54963.
- 67 *Kleitman v. Superior Court* (1999) 74 Cal.App.4th 324, 327. See also Cal. Gov. Code, § 54963.
- 68 *Roberts v. City of Palmdale* (1993) 5 Cal.4th 363.
- 69 80 Ops.Cal.Atty.Gen. 231 (1997).
- 70 76 Ops.Cal.Atty.Gen. 289 (1993).
- 71 Cal. Gov. Code, § 54963.
- 72 Cal. Gov. Code, § 54963.
- 73 Cal. Gov. Code, § 54957.1.



Chapter 6

REMEDIES

Invalidation of action taken	56
Declaratory relief to determine whether past action violated the act.....	57
Civil action to prevent future violations.....	57
Costs and attorney’s fees	58
Misdemeanor penalties	58
Voluntary resolution.....	59

Chapter 6

REMEDIES



A violation of the Brown Act can lead to invalidation of the agency's action, payment of a challenger's attorney fees, public embarrassment, and even criminal prosecution. As explained below, a legislative body often has an opportunity to correct a violation prior to the filing of a lawsuit. Compliance ultimately results from regular training and a good measure of self-regulation on the part of public officials. This chapter discusses the remedies available to the public when that self-regulation is ineffective.

Invalidation of action taken

Any interested person, including the district attorney, may seek to invalidate certain actions of a legislative body on the grounds that they violate the Brown Act.¹ The following actions cannot be invalidated:

- Those taken in substantial compliance with the law. No Brown Act violation is found when the given notice substantially complies with the Brown Act, even when the notice erroneously cites the wrong Brown Act section but adequately advises the public that the legislative body will meet with legal counsel to discuss potential litigation in closed session.²
- Those involving the sale or issuance of notes, bonds, or other indebtedness, or any related contracts or agreements.³
- Those creating a contractual obligation, including a contract awarded by competitive bid for other than compensation for professional services, upon which a party has in good faith relied to its detriment.⁴
- Those connected with the collection of any tax.⁵
- Those in which the complaining party had actual notice at least 72 hours prior to the regular meeting or 24 hours prior to the special meeting, as the case may be, at which the action is taken.⁶

Before filing a court action seeking invalidation, a person who believes that a violation has occurred must send a written "cure or correct" demand to the legislative body. This demand must clearly describe the challenged action and the nature of the claimed violation. This demand must be sent within 90 days of the alleged violation, or within 30 days if the action was taken in open session but in violation of Section 54954.2, which requires (subject to specific exceptions) that a legislative body may act only on items posted on the agenda.⁷ The legislative body then has up to 30 days to cure and correct its action.⁸ The purpose of this requirement is to offer the body an opportunity to consider whether a violation has occurred and, if so, consider correcting the action to avoid the costs of litigation. If the legislative body does not act, any lawsuit must be filed within the next 15 days.⁹

Although just about anyone has standing to bring an action for invalidation,¹⁰ the challenger must show prejudice as a result of the alleged violation.¹¹ An action to invalidate fails to state a cause of action against the agency if the body deliberated but did not take an action.¹²

Declaratory relief to determine whether past action violated the act

Any interested person, including the district attorney, may file a civil action to determine whether a past action of a legislative body constitutes a violation of the Brown Act and is subject to a mandamus, injunction, or declaratory relief action.¹³ Before filing an action, the interested person must, within nine months of the alleged violation of the Brown Act, submit a “cease and desist” letter to the legislative body clearly describing the past action and the nature of the alleged violation.¹⁴ The legislative body has 30 days after receipt of the letter to provide an unconditional commitment to cease and desist from the past action.¹⁵ If the body fails to take any action within the 30-day period or takes an action other than an unconditional commitment, the interested person has 60 days to file an action.¹⁶

The legislative body’s unconditional commitment must be approved at a regular or special meeting as a separate item of business and not on the consent calendar.¹⁷ The unconditional commitment must be substantially in the form set forth in the Brown Act.¹⁸ No legal action may thereafter be commenced regarding the past action.¹⁹ However, an action of the legislative body in violation of its unconditional commitment constitutes an independent violation of the Brown Act, and a legal action consequently may be commenced without following the procedural requirements for challenging past actions.²⁰

The legislative body may rescind its prior unconditional commitment by a majority vote of its membership at a regular meeting as a separate item of business not on the consent calendar. At least 30 days written notice of the intended rescission must be given to each person to whom the unconditional commitment was made and to the district attorney. Upon rescission, any interested person may commence a legal action regarding the past actions without following the procedural requirements for challenging past actions.²¹

Civil action to prevent future violations

The district attorney or any interested person can file a civil action asking the court to do the following:

- Stop or prevent violations or threatened violations of the Brown Act by members of the legislative body.
- Determine the applicability of the Brown Act to actions or threatened future action of the legislative body.
- Determine whether any rule or action by the legislative body to penalize or otherwise discourage the expression of one or more of its members is valid under state or federal law.
- Compel the legislative body to audio-record its closed sessions.²²

PRACTICE TIP: A lawsuit to invalidate must be preceded by a demand to cure and correct the challenged action in order to give the legislative body an opportunity to consider its options. The Brown Act does not specify how to cure or correct a violation; the best method is to rescind the action being complained of and start over, or reaffirm the action if the local agency relied on the action and rescinding the action would prejudice the local agency.

It is not necessary for a challenger to prove a past pattern or practice of violations by the local agency in order to obtain injunctive relief. A court may presume when issuing an injunction that a single violation will continue in the future when the public agency refuses to admit to the alleged violation or to renounce or curtail the practice.²³ A court may not compel elected officials to disclose their recollections of what transpired in a closed session.²⁴

Upon finding a violation of the Brown Act pertaining to closed sessions, a court may compel the legislative body to audio record its future closed sessions.²⁵ In a subsequent lawsuit to enforce the Brown Act alleging a violation occurring in closed session, a court may upon motion of the plaintiff review the audio recording if it finds there is good cause to think the Brown Act has been violated and make public a certified transcript of the relevant portion of the closed session recording.²⁶

Costs and attorney's fees

A plaintiff who successfully invalidates an action taken in violation of the Brown Act or who successfully enforces one of the Brown Act's civil remedies may seek court costs and reasonable attorney's fees. Courts have held that attorney's fees must be awarded to a successful plaintiff unless special circumstances exist that would make a fee award against the public agency unjust.²⁷ When evaluating how to respond to assertions that the Brown Act has been violated, elected officials and their lawyers should assume that attorney's fees will be awarded against the agency if a violation of the Brown Act is proven.

An attorney's fee award may only be directed against the local agency and not the individual members of the legislative body. If the local agency prevails, it may be awarded court costs and attorney's fees if the court finds the lawsuit was clearly frivolous and lacking in merit.²⁸

Misdemeanor penalties

A violation of the Brown Act is a misdemeanor if (1) a member of the legislative body attends a meeting where action is taken in violation of the Brown Act, and (2) the member intends to deprive the public of information that the member knows or has reason to know the public is entitled to.²⁹

"Action taken" is not only an actual vote but also a collective decision, commitment, or promise by a majority of the legislative body to make a positive or negative decision.³⁰ If the meeting involves mere deliberation without the taking of action, there can be no misdemeanor penalty.

A violation occurs for a tentative as well as final decision.³¹ In fact, criminal liability is triggered by a member's participation in a meeting in violation of the Brown Act — not whether that member has voted with the majority or minority, or has voted at all.

As with other misdemeanors, the filing of a complaint is up to the district attorney. Although criminal prosecutions of the Brown Act are uncommon, district attorneys in some counties aggressively monitor public agencies' adherence to the requirements of the law.

Some attorneys and district attorneys take the position that a Brown Act violation may be pursued criminally under Government Code section 1222.³² There is no case law to support this view. If anything, the existence of an express criminal remedy within the Brown Act would suggest otherwise.³³

PRACTICE TIP: Attorney's fees will likely be awarded if a violation of the Brown Act is proven.

Voluntary resolution

Successful enforcement actions for violations of the Brown Act can be costly to local agencies. The district attorney or even the grand jury occasionally becomes involved. Publicity surrounding alleged violations of the Brown Act can result in a loss of confidence by constituents in the legislative body and its members. It is in the agency's interest to consider re-noticing and rehearing, rather than litigating, an item of significant public interest, particularly when there is any doubt about whether the open meeting requirements were satisfied.

Overall, agencies that regularly train their officials and pay close attention to the requirements of the Brown Act will have little reason to worry about enforcement.



Photo credit: Courtesy of the City of West Hollywood. Photo by Jon Viscott.

ENDNOTES

- 1 Cal. Gov. Code, § 54960.1. Invalidation is limited to actions that violate the following sections of the Brown Act: section 54953 (the basic open meeting provision), sections 54954.2 and 54954.5 (notice and agenda requirements for regular meetings and closed sessions), 54954.6 (tax hearings), 54956 (special meetings), and 54596.5 (emergency situations). Violations of sections not listed above cannot give rise to invalidation actions, but they are subject to the other remedies listed in section 54960.1.
- 2 *Castaic Lake Water Agency v. Newhall County Water District* (2015) 238 Cal.App.4th 1196, 1198.
- 3 Cal. Gov. Code, § 54960.1(d)(2).
- 4 Cal. Gov. Code, § 54960.1(d)(3).
- 5 Cal. Gov. Code, § 54960.1(d)(4).
- 6 Cal. Gov. Code, § 54960.1(d)(5).
- 7 Cal. Gov. Code, § 54960.1, subs. (b), (c)(1).
- 8 Cal. Gov. Code, § 54960.1, subd. (c)(2).
- 9 Cal. Gov. Code, § 54960.1, subd. (c)(4).
- 10 *McKee v. Orange Unified School District* (2003) 110 Cal.App.4th 1310, 1318-1319.
- 11 *Cohan v. City of Thousand Oaks* (1994) 30 Cal.App.4th 547, 556, 561.
- 12 *Boyle v. City of Redondo Beach* (1999) 70 Cal.App.4th 1109, 1116-17, 1118.
- 13 Cal. Gov. Code, § 54960.2, subd. (a); Senate Bill No. 1003, Section 4 (2011-2012 Session).
- 14 Cal. Gov. Code, § 54960.2, subs. (a)(1), (2).
- 15 The legislative body may provide an unconditional commitment after the 30-day period. If the commitment is made after the 30-day period, however, the plaintiff is entitled to attorneys' fees and costs. Cal. Gov. Code, § 54960.2, subd. (b).
- 16 Cal. Gov. Code, § 54960.2, subd. (a)(4).
- 17 Cal. Gov. Code, § 54960.2, subd. (c)(2).

- 18 Cal. Gov. Code, § 54960.2, subd. (c)(1).
- 19 Cal. Gov. Code, § 54960.2, subd. (c)(3).
- 20 Cal. Gov. Code, § 54960.2, subd. (d).
- 21 Cal. Gov. Code, § 54960.2, subd. (e).
- 22 Cal. Gov. Code, § 54960, subd. (a).
- 23 *California Alliance for Utility Safety and Education (CAUSE) v. City of San Diego* (1997) 56 Cal.App.4th 1024; *Common Cause v. Stirling* (1983) 147 Cal.App.3d 518, 524; *Accord Shapiro v. San Diego City Council* (2002) 96 Cal.App.4th 904, 916 and fn.6.
- 24 *Kleitman v. Superior Court* (1999) 74 Cal.App.4th 324, 334-36.
- 25 Cal. Gov. Code, § 54960, subd. (b).
- 26 Cal. Gov. Code, § 54960, subd. (c).
- 27 *Los Angeles Times Communications, LLC v. Los Angeles County Board of Supervisors* (2003) 112 Cal. App.4th 1313, 1327-29 and cases cited therein.
- 28 Cal. Gov. Code, § 54960.5.
- 29 Cal. Gov. Code, § 54959. A misdemeanor is punishable by a fine of up to \$1,000 or up to six months in county jail, or both (California Penal Code section 19). Employees of the agency who participate in violations of the Brown Act cannot be punished criminally under section 54959. However, at least one district attorney instituted criminal action against employees based on the theory that they criminally conspired with the members of the legislative body to commit a crime under section 54949.
- 30 Cal. Gov. Code, § 54952.6.
- 31 61 Ops.Cal.Atty.Gen. 283 (1978).
- 32 California Government Code section 1222 provides that “[e]very wilful omission to perform any duty enjoined by law upon any public officer, or person holding any public trust or employment, where no special provision is made for the punishment of such delinquency, is punishable as a misdemeanor.”
- 33 The principle of statutory construction known as *expressio unius est exclusio alterius* supports the view that section 54959 is the exclusive basis for criminal liability under the Brown Act.



1400 K Street, Suite 400, Sacramento, CA 95814
Phone: (916) 658-8200 | Fax: (916) 658-8240
www.calcities.org | www.westerncity.com



City of Garden Grove

INTER-DEPARTMENT MEMORANDUM

To: Garden Grove Administrative Board of Appeals From: William E. Murray, P.E.
Public Works Director

Subject: November 7, 2023 Appeal of Water Bills for 11632 Anabel Avenue Date: March 27, 2024

REQUEST

Appellant, Hoang Viet Van (hereinafter "Mr. Van" or "Appellant"), requests that the Administrative Board of Appeals (the "Board") approve their appeal of the water billing for one billing period from May 23, 2023 to July 21, 2023 (the "Appeal") filed on November 7, 2023, for property located on 11632 Anabel Avenue (See, Attachment 1). The appeal seeks a reduction of the amount of this billing period.

JURISDICTION

Garden Grove Municipal Code section 14.12.070 authorizes the Board to hear appeals of the decision of the Public Works Director denying a request for an adjustment to a water bill as provided below.

- In the event of any dispute as to a charge to a customer, the Public Works Director or designee shall determine if the City is responsible. If, in the determination of said Director, the City is adjudged to be responsible, the Public Works Director may adjust the charge. If, in the determination of the Director, the responsibility is determined to be other than the City, no adjustment shall be granted. After the receipt of the decision of the Public Works Director regarding the responsibility of the disputed charge, the customer shall have the right to file an appeal of such determination within 15 days. The Administrative Board of Appeals shall consider the appeal and the report of the Director regarding the circumstances of this determination. The Board shall decide whether or not to grant an adjustment and the decision of the Board in respect thereto shall be final and conclusive.
- Pursuant to Code of Civil Procedure Section 1094.6, any petition for judicial review shall be filed not later than 90 days after the Board makes its final decision. The provisions of Section 1094.6 shall apply. The secretary of the Board shall notify the appellant that filing a petition for an administrative writ is subject to the 90-day time limitation set forth in Code of Civil Procedure Section 1094.6.

HEARING PROCEDURE

Resolution No. 001-13, which was adopted by the Board on October 16, 2013, pursuant to the authority granted by Garden Grove Municipal Code section 2.54.060, governs the conduct of appeals before the Board. According to the procedures adopted by the Board, appeal hearings shall follow the following format:

- i. Open Hearing
- ii. Presentation by City
- iii. Presentation by Appellant
- iv. Testimony of members of the public opposing administrative decision being appealed from (if any)
- v. Testimony of members of the public supporting administrative decision being appealed from (if any)
- vi. Appellant's rebuttal (limited to addressing points raised by opposition and answering Board's inquiries)
- vii. Close Hearing
- viii. Board discussion and vote.

With respect to the City's presentation, Resolution No. 001-13 states that the City shall have the initial burden to establish that the Appeal is supported by evidence and regulatory authority for the decision. (Resolution 001-13 § i) The City's Appeal and any documentary evidence submitted by the City at the hearing constitutes prima facie evidence of the facts stated in those documents, and support for the Appeal if they (1) describe the conditions, acts or omissions upon which the Appeal was based, (2) set forth the regulatory authority for the Appeal and (3) establish facts supporting the Appeal. (Resolution 001-13 § i)

Upon a showing by the City that the Appeal is supported by evidence and regulatory authority, the burden shifts to the Appellant to establish that (1) the true intent of the municipal code or the rules legally adopted thereunder were incorrectly interpreted by the Public Works Director or designee in issuing the Appeal, (2) that the provisions of the municipal code do not fully apply to the issue addressed by the Appeal, or (3) that "the requirements of the municipal code are adequately satisfied by other means."

The Board then may consider any other relevant evidence on the appeal from any member of the public whose interests are affected by the issue on appeal. Upon conclusion of the presentations by the City, Appellant, and any other interested persons, the Board shall close the hearing on the matter, conduct discussion amongst the members of the Board, and hold a vote regarding the merits of the appeal.

BACKGROUND

The City manages a water system that covers 17.8 square miles and provides safe, clean drinking water to approximately 34,300 water customers. The City recognizes that the leaks in private systems can cause a significant financial burden from

unexpected water usage. City has processes and policies to help with investigating high water bills. The process involves the following:

- Billing system review and reading of account
- Physical inspection and reading of the meter on site, if necessary.
- Provide third party meter testing, upon request.
- Communication of findings to customer.

On November 7, 2023, the City received a notice of appeal and request for an Administrative Board of Appeals hearing from Mr. Van. (See, Attachment 1) The Appeal alleges (1) no visible leak from the water meter was identified by City personnel after bill was received (2) a high water bill should be credited based on the increased water use above average water consumption during the bi-monthly period from May 23, 2023 to July 21, 2023, in the amount of \$532.22 for the use of 111 units (approximately 1.88 units per day), compared to his normal billing that ranges from \$50.00 to \$75.00 based on past consumption patterns, and (3) Mr. Van's independent investigation of the water meter on August 29, 2023 revealed 4 inches of mud surrounding the meter.

On July 26, 2023, City staff had re read the meter before the water bill was generated. It was inspected and verified that there was no leak from and around the meter. On August 30, 2023, Mr. Van made initial contact with the City to inquire about the high water bill. On September 6, 2023, the City performed an in ground meter test for meter accuracy and it had passed. On February 7, 2024, City staff removed the old water meter and replaced it permanently with a new water meter. Old water meter was tested by Westerly on February 8, 2024. The test results passed, according to the American Water Works Association standards. Mr. Van has not paid for the high water billing period in the amount of \$532.22 until this Appeal is resolved.

It is the City's responsibility to maintain the water meter up to the City-side and it is the water customer's responsibility for investigating and repairing any leaks attributed to the customer-owned side of the water meter. Common factors for customer-side leaks: irrigation leaks, internal plumbing leaks, theft, vandalism, negligence by tenants. Upon City staff's review, Mr. Van did not communicate to the City on any "good faith" efforts on their part in regard to performing independent investigations of increased water consumption resulting from his business. This business unit has one, 5/8" X 3/4 " inch, water meter providing water service to 1 unit. This is a machine shop.

Mr. Van received a bill for the period of July 21, 2023 to September 18, 2023 where the total water use amounted to 7 units (approximately 0.12 units per day). The water usage has returned to a normal range following this billing period. City staff has concluded that this temporary increase in water consumption may have been due to other factors on the property owner's side of the water system mentioned above, outside of the City's responsibility.

The City maintains the city-side of the water meter and the property owner is responsible for maintenance of their pipes and water usage on their side of the water meter. Therefore, the water usage during the specified one billing period are attributed to a private property related issue and the City should not be required to reduce the billing in question.

CITY STAFF'S EVIDENCE

In support of the City's effort to determine whether the City's meter was the cause of the increased water usage at the Appellant's property, Attachment 2 shows that the third-party Test Certification for the replaced meter indicates that the meter had passed according to the American Water Works Association standards. The meter was therefore not the cause of the increased billing amounts.

Attachment 3 are the service requests indicating that the City made contact with the Appellant and inspected the meter on July 26, 2023, September 6, 2023 and replaced it on February 7, 2024, with a new meter. The old meter passed testing. On February 7, 2024, the City repaired a backside leak immediately.

Attachment 4 shows the boundaries of the City's water system responsibility. City staff is not able to inspect or examine the private water lines and facilities on Appellant's private property, where leaks or increased water usage would have caused higher water bills.

Finally, the Appellant has not provided the City any information showing that it performed any investigation pertaining to any water leaks or increased consumption during that billing period. Because the City found no leaks or problems with its meter, the Appellant is required to show that a professional plumber, contractor or third party conducted an inspection of the Appellant's water facilities and water usage and found no problems. It should not be sufficient for Appellant to argue that it is not responsible for increased water usage simply because the increase is not typical of their historical water usage.

RECOMMENDATION

Based on the foregoing, City staff recommends that the Board make the following findings of fact:

1. The City was formally informed of a high water bill from Hoang Viet Van on November 7, 2023 regarding a higher than normal water use after receiving a bill for the period of May 23, 2023 to July 21, 2023, in the amount of \$532.22 for the use of 111 units (approximately 1.88 units per day).
2. On July 26, 2023 and September 6, 2023, the City investigated the water meter as the cause of increased water billing.

3. On February 7, 2024, existing water meter was replaced with a new water meter and old meter was passed accuracy test.
4. The Appellant did not provide evidence that its employees or a third-party professional conducted an investigation or evaluation showing the nonexistence of water leaks on the water facilities on Appellant's property or evidence that its tenants did not increase their water consumption.
5. The Public Works Director correctly denied the Appellant's request to adjust and reduce its water bills.

Further, staff recommends that the Board adopt the attached Resolution (Attachment 5) containing the findings outlined above, and denying Hoang Viet Van's November 7, 2023 appeal.

WILLIAM E. MURRAY, P.E.
Public Works Director

Attachments:

- 1) November 7, 2023 Notice re Water Billing Appeal, 11632 Anabel Avenue, Garden Grove, CA
- 2) Water Meter Accuracy Test Conducted on February 8, 2024
- 3) Workorders: July 26, 2023, September 6, 2023 and February 7, 2024
- 4) Diagram
- 5) Resolution#001-2024

ATTACHMENT

1

RECEIVED



CITY OF GARDEN GROVE
REQUEST FOR ADMINISTRATIVE BOARD OF APPEALS HEARING

NOV 07 2023

BY: [Signature]

- Water Billing Appeal
- Notice and Order

TO: City Clerk's Office, City of Garden Grove
11222 Acacia Parkway, Garden Grove, CA 92840
(714) 741-5040

FILING FEE: \$225.00

Pursuant to Municipal Code Section 2.54.110, this appeal form must be filed with the City Clerk's Office within 15 days from the date of determination for water billing disputes, or 15 days from the date of service of the notice and order being appealed.

Appellant(s):

HOANG VIET VAN

Address(es) or legal description:

V & L MACHINE - 11632 ANABEL AVE CA 92843

Describe legal interest of each appellant (indicate if building, land, or both):

OWNER BOTH LAND AND BUILDING

State the specific order or action protested:

APPEAL WATER Bill FROM 5-23-2023 TO 07-21-2023

State the relief sought and reasons why the protested order or action would be reversed, modified, or otherwise set aside. Present material facts to support your contentions (use additional paper if necessary):

SEE ADITIONAL PAPER

I hereby certify under penalty of perjury that the statements contained in this appeal to be the truth to the best of my knowledge.

Appellant(s): HOANG VIET VAN

Address, City, ZIP: 10621 WOODBURY RD GARDEN GROVE CA 92843

Phone No.: (714) 797-3318

Signature of at least one Appellant:

Date:

[Signature]

11-07-2023

November 1, 2023

To Whom It May Concern,

My name is Hoang Van, and I am writing to appeal a water bill I received from May 23, 2023 to July 21, 2023. In that bill, I was charged \$532.22, an unusually high and abnormal amount for my building. Typically, my water bills since 2019 have ranged from approximately \$50 to \$75. For example, the bill from July 21, 2023 to September 18, 2023 was \$73.06.

After receiving the water bill, I immediately went to check the water meter. The building has never experienced any water issues regarding leaks or similar concerns in that matter. The only thing I discovered was mud covering the meter around 4 inches. I took a picture (please view below the letter) and took it to Garden Grove City Hall to address my concerns. I was informed that an official can come to the building to investigate the water meter. Because I was not there when the investigator came a few days after my city hall visit, I was called for an update. In that update, I was told there was no issue found with the water meter. There were no signs of any leaking. The individual informed me that if I would like to further inquire, I may do so at City Hall.

Upon my second visit to City Hall, I was asked various questions regarding typical water usage, for example if there were any unhoused individuals perhaps using water without my knowledge, or if the water was ever accidentally left on. All of my answers were "no" regarding any sort of unknown water usage. All of these matters can be confirmed, as I have security cameras inside and outside of the premises.

Regarding my inquiry about what could be done next, the individual directed me to this appeal form. I strongly and sincerely ask that our inquiry please be investigated. This water bill amount is absurd, as can be seen in our typical water bill amounts since 2019 and on, and it is unfair to be required to pay the \$532.22. In addition, as addressed above, both the investigator and I found no problems with the water meter or any abnormal usage.

I thank you for your sincere time in considering my appeal. I can be contacted at the listed phone number or email address below.

Sincerely,



Hoang Van
(714) 797-3318
hoang919van@gmail.com

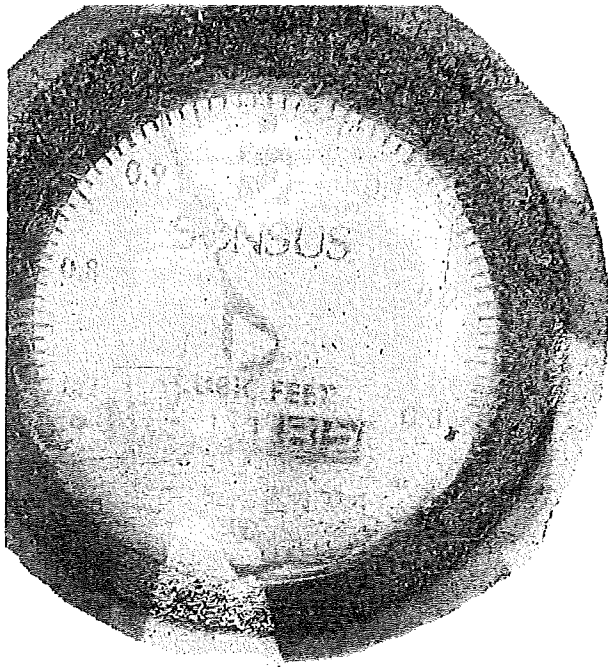

Water Meter: Taken August 29, 2023 at 1:12 PM

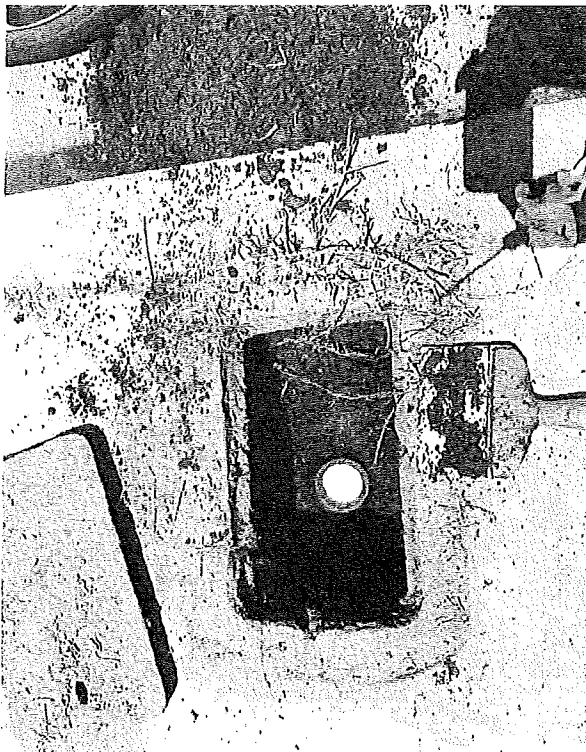

Water Meter: Taken August 29, 2023 at 1:11 PM

V&L MACHINE, INC.
11632 ANABEL AVE
GARDEN GROVE, CA 92843

1900

16-24/1220

DATE 11-7-23

PAY
TO THE
ORDER OF

CITY OF GARDEN GROVE

\$ 225^{XX}/_{XX}

TWO HUNDRED TWENTY FIVE \$ XX
XX

DOLLARS

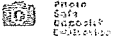

Wells Fargo
12952 Harbor Blvd
Garden Grove, CA 92840

FOR _____

Yennah T. de



ATTACHMENT

2

ATTACHMENT

3

Route History

Service Id or Address

11632 anabel

Action type



Request from:

mm/dd/yyyy

Range

Search:

Service	Type	Requested	Req By	Remark		Notes
35008205	Contact Request	2023-08-31	stephaniea	Customer contact	Meter test passed, will create work order.	2023-09-06 12:58:08 -0700 andrewo 1312 Y
35008205	Prelim Read	2023-07-26	system	Flow indicator not moving/flashing		2023-07-26 12:44:27 -0700 andrewo 1307 Y
35008205	Missing Read	2021-11-16		Meter obstruction		2021-11-16 16:43:39 -0800 davidm Y
35008205	Prelim Read	2021-09-20		M/R		2021-09-20 18:46:54 -0700 josh2926 1115 Y

Showing 1 to 4 of 4 entries

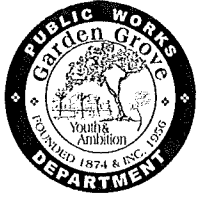

GARDEN GROVE PUBLIC WORKS DEPARTMENT SERVICE REQUEST #554592

Service Request: 554592

Department:

Status: OPEN

Priority: NORMAL

Created at: September 06, 2023 01:03PM

Request: Meter test

Location: 11632 ANABEL AVE,

Public Property: YES

Square Feet:

New Meter: #96219738 (Read: 0)

Old Meter: #63421184 (Read: 1338)

Service line material (City): Copper

Service line material (Customer): Copper

Constuction:

Requester: Andrew Ornelas

Home Phone:

Work Phone:

Other Phone:

Created by: andrewo

Eng. Permit:

Police Num.:

Fire Num.:

Chlorine Res Free:

Chlorine Res Total:

Note #1 (02/07/24 by davido): Meter pulled 2/7/23 to be sent out to be tested.

Task #1

Status: CLOSED on September 06, 2023 01:05PM by Andrew Ornelas

Description: Meter test

Comments: In ground meter test performed and passed.

Category: W99 Water Meter Test (AUTO-NOTIFY) **Assigned to:** Andrew Ornelas

Division: WATER SERVICES

Requester contacted: BY PHONE

Completed by: Andrew Ornelas

ECD:

Task #2

Status: CLOSED on February 07, 2024 02:33PM by David Ortega

Description: Meter Replacement

Comments: Replaced 5/8" meter and gaskets. Backside leaking. Made repairs to copper backside and replaced meter box.

Category: W20 Small Meter Replacement

Assigned to: David Ortega

Division: WATER SERVICES

Requester contacted:

Completed by: David Ortega

ECD:

Task #3

Status: OPENED on February 07, 2024 02:34PM by David Ortega

Description: Concrete patch

Comments: Concrete patch around meter box.

Category: 217 CONCRETE - WATER

Assigned to: Brent Kaylor

Division: STREET MAINT

Completed by:

Requester contacted:

ECD:

Task #4

Status: CLOSED on February 07, 2024 02:41PM by David Ortega

Description: Program Meter

Comments: Programmed meter.

Category: W85 METER PROGRAMMING

Division: WATER SERVICES

Completed by: David Ortega

Assigned to: David Ortega

Requester contacted:

ECD:

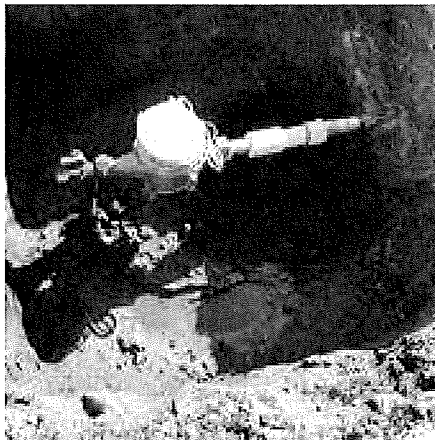
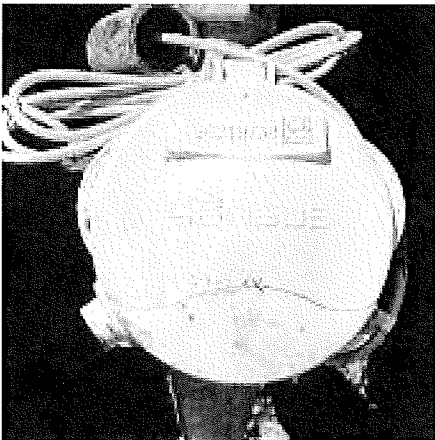
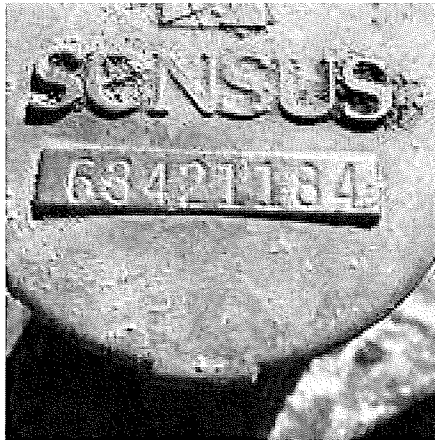
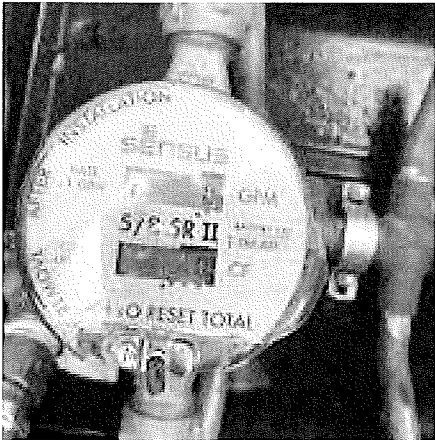
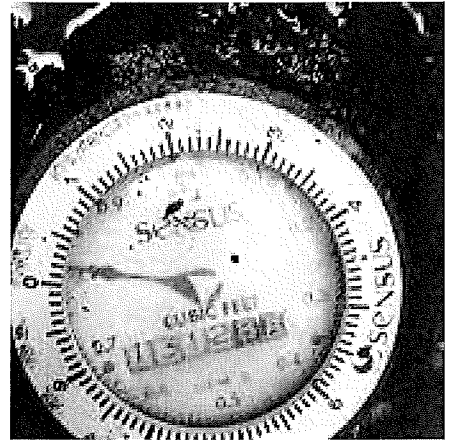
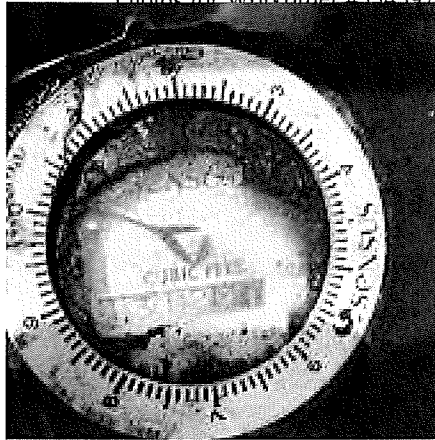

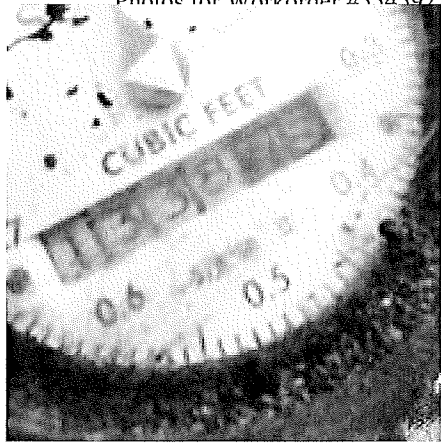
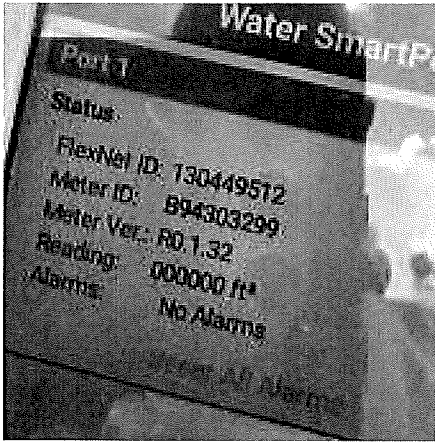

ATTACHMENT

4

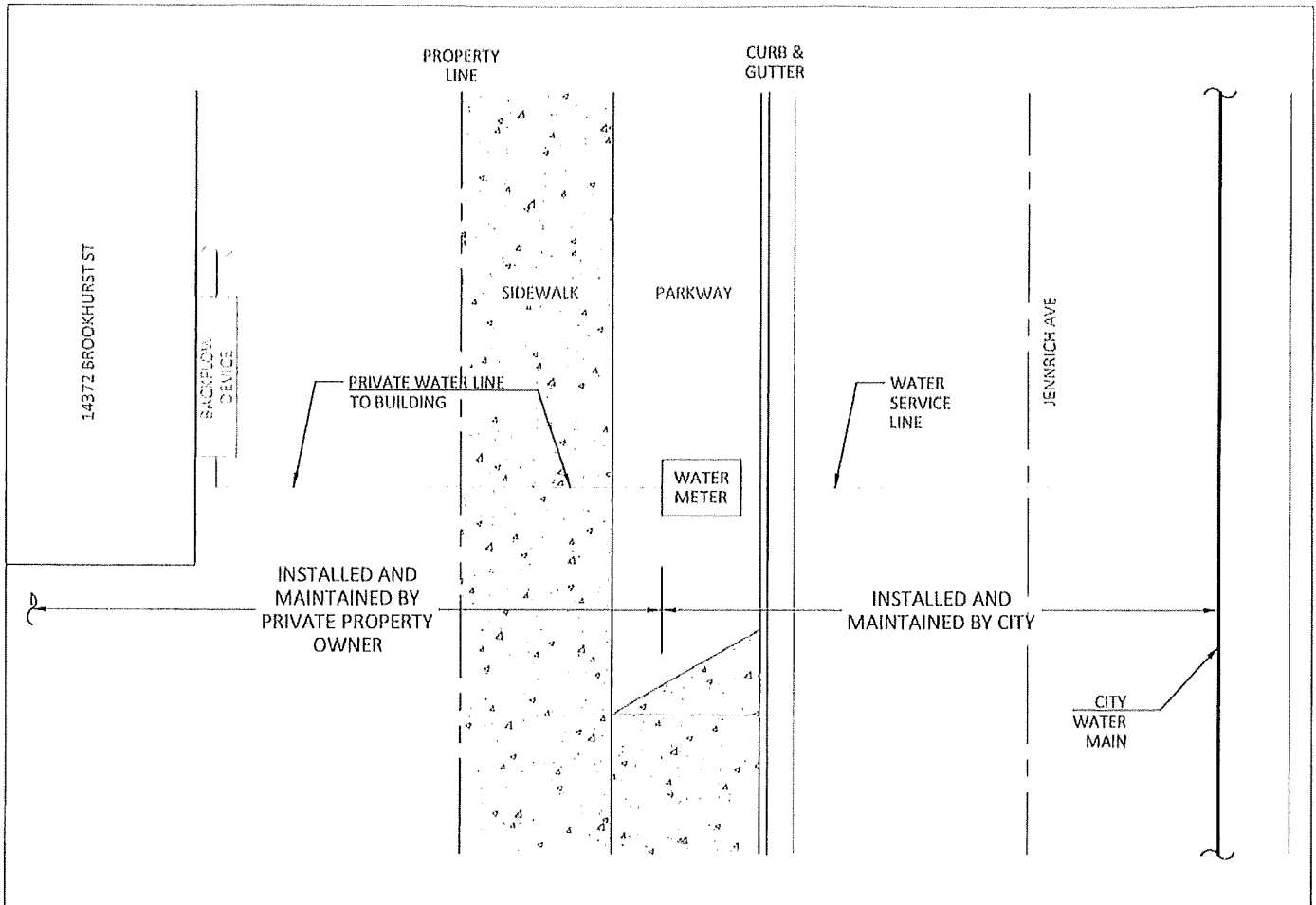

City of
Garden Grove
California

EXHIBIT 1
OWNER / CITY MAINTENANCE RESPONSIBILITY
FOR WATER SERVICE LINE

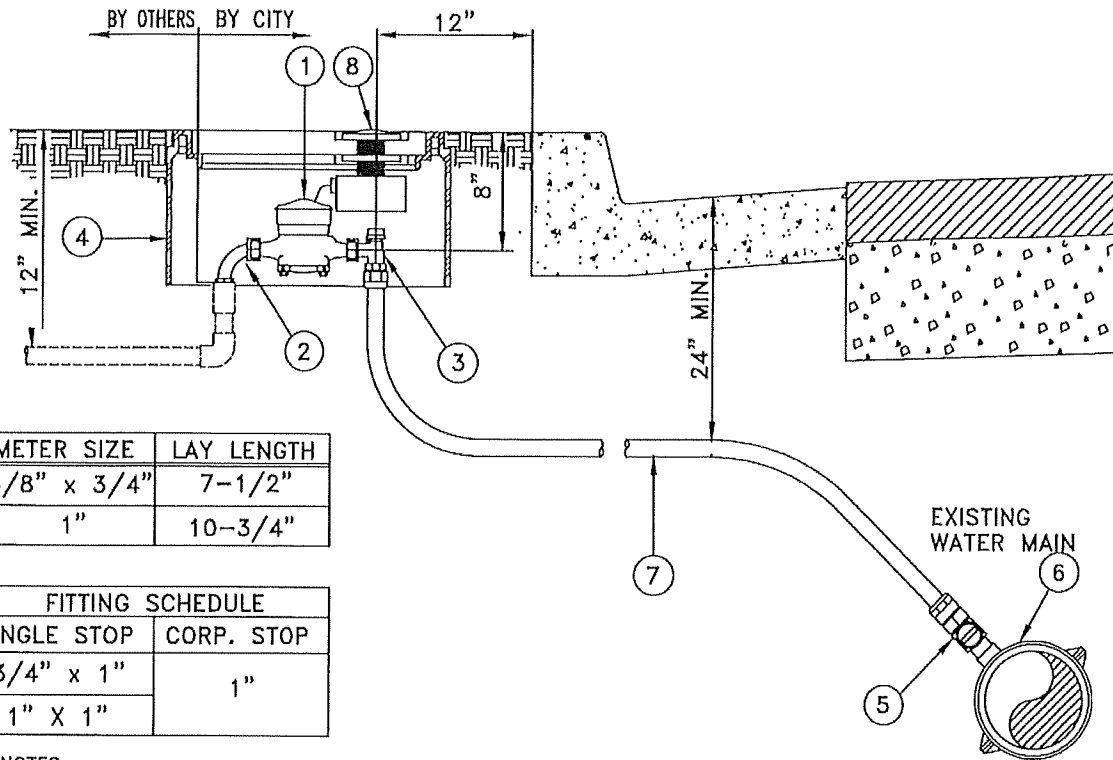

METER SIZE	LAY LENGTH
5/8" x 3/4"	7-1/2"
1"	10-3/4"

FITTING SCHEDULE	
ANGLE STOP	CORP. STOP
3/4" x 1"	1"
1" x 1"	

NOTES

1. ALL CITY SERVICES TO BE TYPE "K" SOFT COPPER.
2. TUBING TO BE ONE CONTINUOUS PIECE, NO SPLICES OR HEATING PERMITTED UNLESS APPROVED BY WATER SERVICES.
3. TAPS SHALL BE MADE AT LEAST 12" FROM ANY OTHER TAP OR COUPLING. STAGGER ANGLE OF TAPS MADE NEXT TO EACH OTHER 15°.
4. METER, METER BOX, ANGLE METER VALVE AND TAILPIECE, BY CITY AT CONTRACTOR'S EXPENSE, UNLESS OTHERWISE APPROVED.

MATERIAL LIST

ITEM NO.	QUAN.	DESCRIPTION	MFR.
①	1	5/8" OR 1" SMART METER	SENSUS, SRII
②	1	3/4" OR 1" ANGLE METER COUPLING	
③	1	3/4" x 1" OR 1" x 1" BALL ANGLE METER VALVE, COMPRESSION TYPE OR APPROVED EQUAL	MUELLER, JONES OR FORD
④	1	POLYMER METER BOX (DFW486WBC-12-1 OR APPROVED EQUAL)	DFW PLASTICS OR APPROVED EQUAL
⑤	1	1" CORPORATION STOP (COMPRESSION TYPE), BALL TYPE, C.C. THREAD	MUELLER, JONES OR FORD
⑥	1	SERVICE SADDLE DOUBLE STRAP (FORD 202BSD OR APPROVED EQUAL)	MUELLER, JONES OR FORD
⑦	AS NEEDED	1# SOFT COPPER TUBING, TYPE "K"	
⑧	1	FLEXNET SMARTPOINT 520M MODULE (OR APPROVED EQUAL)	SENSUS



**1" COPPER WATER SERVICE
INSTALLATION FOR 5/8" & 1" METERS**

Approved *[Signature]* Date 05-18-21
City Engineer R.C.E. 52125 Exp. 12-31-22

REVISIONS	BY	DATE

STD. PLAN NUMBER
B-721
SHEET 1 OF 1

ATTACHMENT

5

RESOLUTION NO. 001-2024

A RESOLUTION OF THE ADMINISTRATIVE BOARD OF APPEALS OF THE CITY OF GARDEN GROVE, CALIFORNIA, DENYING THE APPEAL OF HOANG VIET VAN OF THE GARDEN GROVE PUBLIC WORKS DIRECTOR'S DENIAL OF ITS REQUEST TO ADJUST WATER BILLS FOR ONE BILLING PERIOD FROM MAY 23, 2023 TO JULY 21, 2023.

WHEREAS, Hoang Viet Van ("Appellant") requested an adjustment to his water bill for one billing period from May 23, 2023 to July 21, 2023; and

WHEREAS, the Public Works Director denied Appellant's request and Appellant appealed the Director's decision on November 7, 2023; and

WHEREAS, on March 27, 2024, a hearing before the Administrative Board of Appeals of the City of Garden Grove was held at which the Administrative Board of Appeals considered testimony and evidence related to the Appellant's appeal of the Director's decision and continued the hearing to receive additional information requested by the Board; and

WHEREAS, Appellant and all other persons with an interest in the subject matter of the appeal were afforded an opportunity to be heard and present evidence to the Administrative Board of Appeals of the City of Garden Grove at its March 27, 2024 hearing.

NOW, THEREFORE, THE ADMINISTRATIVE BOARD OF APPEALS OF THE CITY OF GARDEN GROVE, CALIFORNIA, DOES RESOLVE, DECLARE, DETERMINE, AND ORDER AS FOLLOWS:

SECTION 1. The Administrative Board of Appeals of the City of Garden Grove hereby makes the following findings of fact:

1. The City was formally informed of a high water bill from Hoang Viet Van on August 30, 2023 regarding a higher than normal water use after receiving a bill for the period of May 23, 2023 to July 21, 2023, in the amount of \$532.22 for the use of 111 units (approximately 1.88 units per day).
2. On July 26, 2023, City staff had read the meter before the subject water bill was generated. At the time, the meter was inspected and verified that there was no leak from and around the meter.
3. On August 29, 2024, Appellant's independent investigation of the water meter revealed 4 inches of mud surrounding the meter.
4. On September 6, 2023, after being notified of the high water bill by Appellant, the City performed an in ground meter test for meter accuracy and it passed.
5. On February 7, 2024, City staff removed the old water meter and replaced it permanently with a new water meter. The backside of the connection, which is not metered, was noted to have a leak, which was repaired at that time.

- 6. The old water meter was tested by Westerly on February 8, 2024. The test results passed, according to the American Water Works Association standards.
- 7. The Appellant did not provide evidence that he or a third-party professional conducted an investigation or evaluation showing the nonexistence of water leaks on the water facilities on Appellant’s property, or that the Machine Shop operated at the property did not experience increased usage of water for the subject billing period.
- 8. The Public Works Director correctly denied the Appellant’s request to adjust and reduce its water bills.

SECTION 2. Based on the findings of fact referenced herein and after consideration of all relevant testimony and evidence submitted at the March 27, 2024 meeting of the Administrative Board of Appeals of the City of Garden Grove, the decision of the Public Works Director denying Appellant’s request for billing adjustments is hereby affirmed, and the appeal filed by Hoang View Van on November 7, 2023, is hereby denied.

SECTION 3. The Building Official is directed to provide notice of the decision of the Administrative Board of Appeals and of this Resolution to Appellant, Hoang Viet Van within seven (7) days of the date this Resolution is adopted.

SECTION 4. This Resolution shall become final effective immediately.

Adopted this 27th day of March, 2024.

ATTEST:

CHAIR

SECRETARY

STATE OF CALIFORNIA)
COUNTY OF ORANGE) SS:
CITY OF GARDEN GROVE)

I, JUDITH MOORE, Secretary of the City of Garden Grove Administrative Board of Appeals, do hereby certify that the foregoing Resolution was duly adopted by the Administrative Board of Appeals of the City of Garden Grove, California, at a Special Meeting held on the 27th day of March, 2024, by the following vote:

AYES: BOARD MEMBERS:
NOES: BOARD MEMBERS:
ABSTAIN BOARD MEMBERS:
ABSENT: BOARD MEMBERS:

SECRETARY

PLEASE NOTE: Any request for court review of this decision must be filed within 90 days of the date this decision was final (See Code of Civil Procedure Section 1094.6).

City of Garden Grove

INTER-DEPARTMENT MEMORANDUM

To: Garden Grove Administrative Board of Appeals From: William E. Murray, P.E.
Public Works Director

Subject: January 4, 2024 Appeal of Water Bills for 12001 West Street Date: March 27, 2024

REQUEST

Appellant, Edgar Rojas (hereinafter "Mr. Rojas" or "Appellant"), requests that the Administrative Board of Appeals (the "Board") approve their appeal of the water billing for one billing period from March 23, 2023 to May 18, 2023 (the "Appeal") filed on January 4, 2024 for property located on 12001 West Street (See, Attachment 1). The appeal seeks a reduction of the amount of this billing period.

JURISDICTION

Garden Grove Municipal Code section 14.12.070 authorizes the Board to hear appeals of the decision of the Public Works Director denying a request for an adjustment to a water bill as provided below.

- In the event of any dispute as to a charge to a customer, the Public Works Director or designee shall determine if the City is responsible. If, in the determination of said Director, the City is adjudged to be responsible, the Public Works Director may adjust the charge. If, in the determination of the Director, the responsibility is determined to be other than the City, no adjustment shall be granted. After the receipt of the decision of the Public Works Director regarding the responsibility of the disputed charge, the customer shall have the right to file an appeal of such determination within 15 days. The Administrative Board of Appeals shall consider the appeal and the report of the Director regarding the circumstances of this determination. The Board shall decide whether or not to grant an adjustment and the decision of the Board in respect thereto shall be final and conclusive.
- Pursuant to Code of Civil Procedure Section 1094.6, any petition for judicial review shall be filed not later than 90 days after the Board makes its final decision. The provisions of Section 1094.6 shall apply. The secretary of the Board shall notify the appellant that filing a petition for an administrative writ is subject to the 90-day time limitation set forth in Code of Civil Procedure Section 1094.6.

HEARING PROCEDURE

Resolution No. 001-13, which was adopted by the Board on October 16, 2013, pursuant to the authority granted by Garden Grove Municipal Code section 2.54.060, governs the conduct of appeals before the Board. According to the procedures adopted by the Board, appeal hearings shall follow the following format:

- i. Open Hearing
- ii. Presentation by City
- iii. Presentation by Appellant
- iv. Testimony of members of the public opposing administrative decision being appealed from (if any)
- v. Testimony of members of the public supporting administrative decision being appealed from (if any)
- vi. Appellant's rebuttal (limited to addressing points raised by opposition and answering Board's inquiries)
- vii. Close Hearing
- viii. Board discussion and vote.

With respect to the City's presentation, Resolution No. 001-13 states that the City shall have the initial burden to establish that the Appeal is supported by evidence and regulatory authority for the decision. (Resolution 001-13 § i) The City's Appeal and any documentary evidence submitted by the City at the hearing constitutes prima facie evidence of the facts stated in those documents, and support for the Appeal if they (1) describe the conditions, acts or omissions upon which the Appeal was based, (2) set forth the regulatory authority for the Appeal and (3) establish facts supporting the Appeal. (Resolution 001-13 § i)

Upon a showing by the City that the Appeal is supported by evidence and regulatory authority, the burden shifts to the Appellant to establish that (1) the true intent of the municipal code or the rules legally adopted thereunder were incorrectly interpreted by the Public Works Director or designee in issuing the Appeal, (2) that the provisions of the municipal code do not fully apply to the issue addressed by the Appeal, or (3) that "the requirements of the municipal code are adequately satisfied by other means."

The Board then may consider any other relevant evidence on the appeal from any member of the public whose interests are affected by the issue on appeal. Upon conclusion of the presentations by the City, Appellant, and any other interested persons, the Board shall close the hearing on the matter, conduct discussion amongst the members of the Board, and hold a vote regarding the merits of the appeal.

BACKGROUND

The City manages a water system that covers 17.8 square miles and provides safe, clean drinking water to approximately 34,300 water customers. The City recognizes that the leaks in private systems can cause a significant financial burden from

unexpected water usage. City has processes and policies to help with investigating high water bills. The process involves the following:

- Billing system review and reading of account
- Physical inspection and reading of the meter on site, if necessary.
- Provide third party meter testing, upon request.
- Communication of findings to customer.

On January 4, 2024, the City received a notice of appeal and request for an Administrative Board of Appeals hearing from Mr. Rojas (See, Attachment 1) The Appeal alleges (1) an abnormal high water bill resulting from a water meter should be credited during billing period from March 23, 2023 to May 18, 2023 (2) normal bill water bill within 2 units for a billing period according to the referenced previous bill for the period from January 17, 2023 to March 23, 2023.

On January 23, 2023, City staff had re read the meter and verified that the low flow indicator was moving, indicating a leak. A water wise brochure and door hanger was placed that references "low flow indicator is moving" and the current read. On March 28, 2023, City staff was conducting routine meter reading and noticed the low flow indicator was moving with water usage resulting in a read of 1836. City staff re read the meter which resulted in a read of 1943. The bill was inadvertently generated at 2 units, in which it should have been at 109 units billed during the period from January 17, 2023 to March 23, 2023. The previous billing units of 109 were combined with the billing units of 82 within the billing period from March 23, 2023 to May 18, 2023, for a total of 191 units for a four month period.

City staff performed a re-read of the meter on May 23, 2023 and confirmed a high water usage. On May 26, 2023, Mr. Rojas made initial contact with the City requesting a re-read of the water meter due to a higher than normal water use after receiving a bill for the period of March 23, 2023 to May 18, 2023, in the amount of \$928.05 for the use of 191 units (approximately 3.41 units per day). City staff responded on May 26, 2023 and confirmed that there was no leak from and around the meter. June 6, 2023, City staff informed Mr. Rojas of the billing cycle error and the account correction took place, as outlined above. On September 15, 2023, the City performed an in ground meter test for meter accuracy and it had passed. On December 8, 2023, City staff removed the old water meter and replaced it permanently with a new water meter. Old water meter was tested by Westerly on December 11, 2023. The test results showed that the old meter was under registering water flow to the customer's benefit. Mr. Rojas has not paid for the high water billing period plus subsequent water bills in the amount of \$1,334.96 until this Appeal is resolved.

It is the City's responsibility to maintain the water meter up to the City-side and it is the water customer's responsibility for investigating and repairing any leaks attributed to the customer-owned side of the water meter. Common factors for customer-side leaks: irrigation leaks, internal plumbing leaks, theft, vandalism, negligence by occupants. Upon City staff's review, Mr. Rojas did not communicate to

the City on any "good faith" efforts on their part in regard to performing independent investigations of increased water consumption resulting from his residency. This single family residential unit has one, 5/8" X 3/4 " inch, water meter providing water service to 1 unit.

Mr. Rojas received a bill for the period of March 23, 2023 to May 18, 2023, the total water use amounted to 191 units (approximately 3.41 units per day). City staff has concluded that this temporary increase in water consumption may have been due to other factors on the property owner's side of the water system mentioned above, outside of the City's responsibility.

The City maintains the city-side of the water meter and the property owner is responsible for maintenance of their pipes and water usage on their side of the water meter. There was no water leak at the City's side of the meter. Therefore, the water usage during the specified one billing period are attributed to a private property related issue and the City should not be required to reduce the billing in question.

CITY STAFF'S EVIDENCE

In support of the City's effort to determine whether the City's meter was the cause of the increased water usage at the Appellant's property, Attachment 2 shows that the third-party Test Certification for the replaced meter indicates that the meter test results did not pass, according to the American Water Works Association standards. This means that the meter was under measuring to the benefit of the Appellant. The meter was therefore not the cause of the increased billing amounts.

Attachment 3 are the service requests indicating that the City made contact with the Appellant and inspected the meter on January 23, 2023, May 23, 2023 and September 15, 2023, and replaced it on December 8, 2023 with a new meter.

Attachment 4 shows the boundaries of the City's water system responsibility. City staff is not able to inspect or examine the private water lines and facilities on Appellant's private property, where leaks or increased water usage would have caused higher water bills.

Finally, the Appellant has not provided the City any information showing that it performed any investigation pertaining to any water leaks or increased consumption during that billing period. Because the City found no leaks or problems with its meter, the Appellant is required to show that a professional plumber, contractor or third party conducted an inspection of the Appellant's water facilities and water usage and found no problems. It should not be sufficient for Appellant to argue that it is not responsible for increased water usage simply because the increase is not typical of their historical water usage.

RECOMMENDATION

Based on the foregoing, City staff recommends that the Board make the following findings of fact:

1. The City was formally informed of a high water bill from Edgar Rojas January 4, 2024 regarding a higher than normal water use after receiving a bill for the period of March 23, 2023 to May 18, 2023, in the amount of \$928.05 for the use of 191 units (approximately 3.41 units per day).
2. On January 23, 2023, March 28, 2023, May 23, 2023 and September 15, 2023, the City investigated the water meter as the cause of increased water billing.
3. On December 8, 2023, existing water meter was replaced with a new water meter and old meter did not pass accuracy test and deemed to be under registering water flow to the customer's benefit.
4. The Appellant did not provide evidence that its employees or a third-party professional conducted an investigation or evaluation showing the nonexistence of water leaks on the water facilities on Appellant's property or evidence that its occupants did not increase their water consumption.
5. The Public Works Director correctly denied the Appellant's request to adjust and reduce its water bills.

Further, staff recommends that the Board adopt the attached Resolution (Attachment 5) containing the findings outlined above, and denying Edgar Rojas January 4, 2024 appeal.



WILLIAM E. MURRAY, P.E.
Public Works Director

Attachments:

- 1) January 4, 2024 Notice re Water Billing Appeal, 12001 West Street, Garden Grove, CA
- 2) Water Meter Accuracy Test Conducted on December 11, 2023
- 3) Workorders: January 23, 2023, September 15, 2023, December 8, 2023
- 4) Door Hanger and Water Wise Brochure
- 5) Diagram
- 6) Resolution#002-2024

ATTACHMENT

1



CITY OF GARDEN GROVE

REQUEST FOR ADMINISTRATIVE BOARD OF APPEALS HEARING

RECEIVED
CITY CLERK'S OFFICE

2024 JAN -4 PM 5:13

Water Billing Appeal

TO: City Clerk's Office, City of Garden Grove
11222 Acacia Parkway, Garden Grove, CA 92840
(714) 741-5040

Notice and Order

FILING FEE: \$225.00

Pursuant to Municipal Code Section 2.54.110, this appeal form must be filed with the City Clerk's Office within 15 days from the date of determination for water billing disputes, or 15 days from the date of service of the notice and order being appealed.

Appellant(s):

Edgar Rojas

Address(es) or legal description:

12001 West St. Garden Grove, CA 92840

Describe legal interest of each appellant (indicate if building, land, or both):

Renter at Property

State the specific order or action protested:

Appealing extremely high water bill

State the relief sought and reasons why the protested order or action would be reversed, modified, or otherwise set aside. Present material facts to support your contentions (use additional paper if necessary):

I'm looking to pay the just amount. Bill was awfully high compared to what we normally pay.

I hereby certify under penalty of perjury that the statements contained in this appeal to be the truth to the best of my knowledge.

Appellant(s): Edgar Rojas

Address, City, ZIP: 12001 West St. Garden Grove, CA 92840

Phone No.: 714-612-1041

Signature of at least one Appellant:

Date:

01/04/24



CITY HALL

11222 Acacia Parkway
Garden Grove, CA 92840

7:30 AM - 5:30 PM Monday - Thursday

7:30 AM - 5:00 PM Alternating Fridays

GARDEN GROVE

- To pay online visit <https://ggcity.org/water>
- To pay by phone, please call 1-888-867-2992
- Make checks payable to City of Garden Grove

ROJAS, EDGAR
12001 West St
Garden Grove CA, 92840-3701

Service Period	Number of Days
05/18/2023 to 07/19/2023	62

Previous Read	Current Read	Units Used
2027	2045	18

Approximately 13,464 gallons used for this billing cycle. Each billing unit equals 100 cubic feet or 748 gallons of water.

Consumption in Billing Units

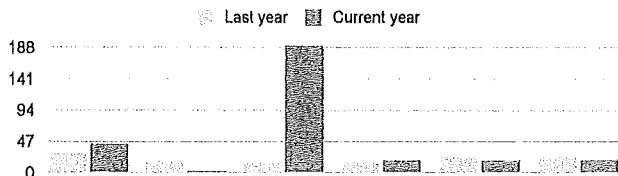

From least current billing to most current

AutoPay + Paperless Billing
On time. Every time. <https://ggcity.org/h2o/guest>

MOVING? Contact the City service to close VACANT BUILDING? your water account. (714) 741-5078

NEW WATER RATES EFFECTIVE JANUARY 11, 2024
For more info, visit
<http://www.ggcity.org/finance/water-rates>

Service Address:	12001 WEST ST
Billed On:	07/24/2023
Next Approximate Read:	09/15/2023

ACCOUNT INFORMATION

Customer: ROJAS, EDGAR
Account Number: 330004012
Service Address: 12001 WEST ST
Service Type: Single family home
Meter Size: 5/8"x3/4"
Bill Date: 07/24/2023

ACCOUNT ACTIVITY

Previous Balance: 948.75

CURRENT CHARGES

Water Tier 1 18 units @ \$3.26	58.68
Water Service Charge	33.85
Water Capital Improvement	7.00
Sewer Service Charge	21.22

Current Charges: \$120.75

Amount Now Due: \$1,069.50

Due by 08/29/2023

If paid later than 09/05/2023 pay \$1,090.20

Low-Income Household Water Assistance Program
(714) 839-6199 • capoc.org/water • LIHWAP@capoc.org

Water Emergency? Call (714) 741-5395.
Customers and plumbers are NOT to operate the water meter shut off valve. Damage to the meter shut off valve will be billed.

PLEASE RETURN THIS PORTION WITH WATER PAYMENT

ACCOUNT NUMBER:	330004012
AMOUNT DUE:	\$1,069.50
DUE DATE:	08/29/2023

Check here for address correction. Fill out form on back.



CITY OF GARDEN GROVE
PO BOX 3070
Garden Grove, CA 92842-3070

Customer Service: (714) 741-5078 • <https://ggcity.org>
Pay online at <https://ggcity.org/water>
To pay by phone, please call 1-888-867-2992.



CITY HALL
11222 Acacia Parkway
Garden Grove, CA 92840

7:30 AM - 5:30 PM Monday - Thursday
7:30 AM - 5:00 PM Alternating Fridays

GARDEN GROVE

- To pay online visit <https://ggcity.org/water>
- To pay by phone, please call **1-888-867-2992**
- Make checks payable to City of Garden Grove

ROJAS, EDGAR
12001 West St
Garden Grove CA, 92840-3701

Service Period	Number of Days
01/17/2023 to 03/23/2023	65

Previous Read	Current Read	Units Used
1834	1836	2

Approximately 1,496 gallons used for this billing cycle. Each billing unit equals 100 cubic feet or 748 gallons of water.

Consumption in Billing Units

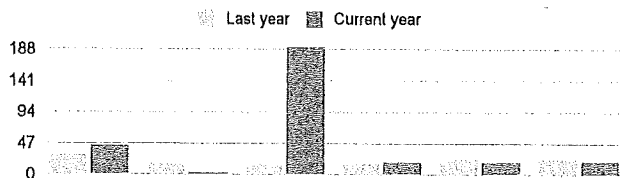

From least current billing to most current

AutoPay + Paperless Billing
On time. Every time. <https://ggcity.org/h2o/guest>

MOVING? Contact the City service to close VACANT BUILDING? your water account. (714) 741-5078

NEW WATER RATES EFFECTIVE JANUARY 11, 2024
For more info, visit
<http://www.ggcity.org/finance/water-rates>

ACCOUNT INFORMATION

Customer: ROJAS, EDGAR
Account Number: 330004012
Service Address: 12001 WEST ST
Service Type: Single family home
Meter Size: 5/8"x3/4"
Bill Date: 03/28/2023

ACCOUNT ACTIVITY

Previous Balance: 0.00

CURRENT CHARGES

Water Tier 1 2 units @ \$3.16	6.32
Water Service Charge	33.85
Water Capital Improvement	7.00
Low Use Credit	-6.32
Sewer Service Charge	21.22

Current Charges: \$62.07
Amount Now Due: \$62.07
Due by 05/02/2023

If paid later than 05/09/2023 pay \$82.77

Low-Income Household Water Assistance Program
(714) 839-6199 • capoc.org/water • LIHWAP@capoc.org

Water Emergency? Call (714) 741-5395.
Customers and plumbers are NOT to operate the water meter shut off valve. Damage to the meter shut off valve will be billed.

PLEASE RETURN THIS PORTION WITH WATER PAYMENT

ACCOUNT NUMBER: 330004012
AMOUNT DUE: \$62.07
DUE DATE: 05/02/2023

Check here for address correction. Fill out form on back.



CITY OF GARDEN GROVE
PO BOX 3070
Garden Grove, CA 92842-3070

Service Address:	12001 WEST ST
Billed On:	03/28/2023
Next Approximate Read:	05/20/2023

Customer Service: (714) 741-5078 • <https://ggcity.org>

Pay online at <https://ggcity.org/water>

To pay by phone, please call 1-888-867-2992.

**CITY HALL**11222 Acacia Parkway
Garden Grove, CA 92840

7:30 AM - 5:30 PM Monday - Thursday

7:30 AM - 5:00 PM Alternating Fridays

GARDEN GROVE

- To pay online visit <https://ggcity.org/water>
- To pay by phone, please call 1-888-867-2992
- Make checks payable to City of Garden Grove

ROJAS, EDGAR
12001 West St
Garden Grove CA, 92840-3701

Service Period	Number of Days
03/23/2023 to 05/18/2023	56

Previous Read	Current Read	Units Used
1836	2027	191

Approximately 142,868 gallons used for this billing cycle. Each billing unit equals 100 cubic feet or 748 gallons of water.

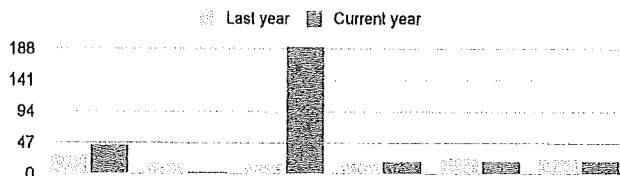
Consumption in Billing Units

From least current billing to most current

AutoPay + Paperless Billing
 On time. Every time. <https://ggcity.org/h2o/guest>
MOVING? Contact the City service to close VACANT BUILDING? your water account. (714) 741-5078
NEW WATER RATES EFFECTIVE JANUARY 11, 2024For more info, visit
<http://www.ggcity.org/finance/water-rates>

Service Address:	12001 WEST ST
Billed On:	05/23/2023
Next Approximate Read:	07/15/2023

ACCOUNT INFORMATIONCustomer: ROJAS, EDGAR
Account Number: 330004012
Service Address: 12001 WEST ST
Service Type: Single family home
Meter Size: 5/8"x3/4"
Bill Date: 05/23/2023**ACCOUNT ACTIVITY**

Previous Balance: 0.00

CURRENT CHARGES

Water Tier 1 33 units @ \$3.26	107.58
Water Tier 2 158 units @ \$4.80	758.40
Water Service Charge	33.85
Water Capital Improvement	7.00
Sewer Service Charge	21.22

Current Charges: \$928.05**Amount Now Due: \$928.05****Due by 06/27/2023**

If paid later than 07/04/2023 pay \$948.75

Low-Income Household Water Assistance Program
(714) 839-6199 • capoc.org/water • LIHWAP@capoc.org**Water Emergency? Call (714) 741-5395.**
Customers and plumbers are NOT to operate the water meter shut off valve. Damage to the meter shut off valve will be billed.

PLEASE RETURN THIS PORTION WITH WATER PAYMENT

ACCOUNT NUMBER: 330004012**AMOUNT DUE: \$928.05****DUE DATE: 06/27/2023** Check here for address correction. Fill out form on back.**CITY OF GARDEN GROVE**
PO BOX 3070
Garden Grove, CA 92842-3070Customer Service: (714) 741-5078 • <https://ggcity.org>Pay online at <https://ggcity.org/water>

To pay by phone, please call 1-888-867-2992.

ATTACHMENT

2

ATTACHMENT

3

Route History

Service Id or Address

12001 West street

Action type



Request from:

mm/dd/yyyy

Range

Search:

Service	Type	Requested	Req By	Remark	Notes				
33000401	Contact Request	2023-09-15	steven	Customer contact	Spoke with Edgar who said he would appeal water bill, Steve and I performed in ground meter test since we were there already and test passed. (WO#555474)	2023-09-15 09:55:37 -0700	andrewo	2063	Y
33000401	Re-Read Request	2023-05-26	kennethl		Lfi not moving.	2023-05-26 09:06:06 -0700	andrewo	2029	Y
33000401	Prelim Read	2023-05-22	system	Flow indicator not moving/flashing		2023-05-23 12:38:57 -0700	andrewo	2029	Y
33000401	Prelim Read	2023-03-28	system	Meter not stopped		2023-03-28 11:23:47 -0700	andrewo	1943	Y
33000401	Prelim Read	2023-01-23	system	Flow indicator moving/flashing		2023-01-23 12:55:29 -0800	davidm	1834	Y

Showing 1 to 5 of 5 entries



GARDEN GROVE PUBLIC WORKS DEPARTMENT
SERVICE REQUEST #555474

Service Request: 555474

Department:

Status: CLOSED

Priority: NORMAL

Created at: September 15, 2023 09:55AM

Request: Meter test

Location: 12001 WEST ST,

Public Property: YES

Square Feet:

Requester: Andrew Ornelas

Home Phone:

Work Phone:

Other Phone:

Created by: andrewo

Eng. Permit:

Police Num.:

Fire Num.:

Task #1

Status: CLOSED on September 15, 2023 09:56AM by Andrew Ornelas

Description: Meter test

Comments: Meter test performed and passed.

Category: W99 Water Meter Test (AUTO-NOTIFY) **Assigned to:**

Division: WATER SERVICES

Requester contacted:

Completed by: Andrew Ornelas

ECD:

Photos for Workorder #555474

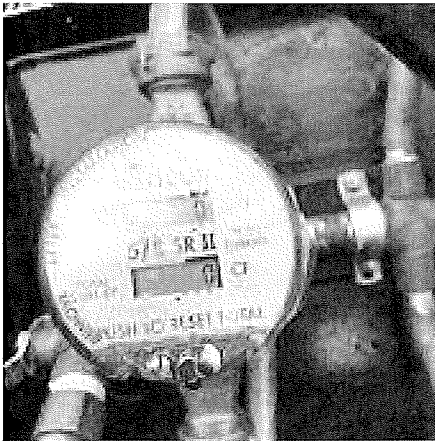

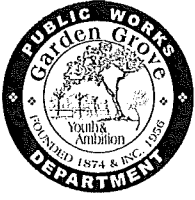

GARDEN GROVE PUBLIC WORKS DEPARTMENT SERVICE REQUEST #561654

Service Request: 561654
Department: Public Works
Status: CLOSED
Priority: NORMAL
Created at: December 08, 2023 02:30PM

Requester: Les R
Home Phone:
Work Phone:
Other Phone:
Created by: jessem

Request: Per Les, remove meter for accuracy testing and replace with new meter and program.

Location: 12001 WEST ST,

Public Property: YES
Square Feet:

Eng. Permit:
Police Num.:
Fire Num.:

New Meter: #96219813 (Read: 0)
Old Meter: #59692849 (Read: 2090)
Service line material (City): Copper
Service line material (Customer): PVC
Constuction:
Total cost: \$147.22

Chlorine Res Free: 0.34
Chlorine Res Total: 0.68

Task #1

Status: CLOSED on December 08, 2023 04:30PM by Jesse Montgomery

Description:

Comments: Pulled meter and plugged/tagged. Installed new radio 5/8 meter and programmed.

Category: W01 After Hours Standby (AUTO-

Assigned to: Jesse Montgomery

Division: WATER SERVICES

Requester contacted:

Completed by: Jesse Montgomery

ECD:

Total task cost: \$147.22

Labor Costs

Name	Reg	OT	Total
Jesse Montgomery	0 hours	2.0 hours	\$147.22
TOTAL	0 hours	2.0 hours	\$147.22

Photo for Workorder #561654

Reading: 000000 ft³

Alarms: No Alarms

Register Settings

Name: Electronic Register +

Type: Smart Meter Gen 2

Unit: Cubic feet

AMR Resolution: Onas

History Resolution: 1s of Cubic feet

Alarm Settings

Reverse flow: Disabled

High flow: Disabled

Continuous flow: Disabled

Details

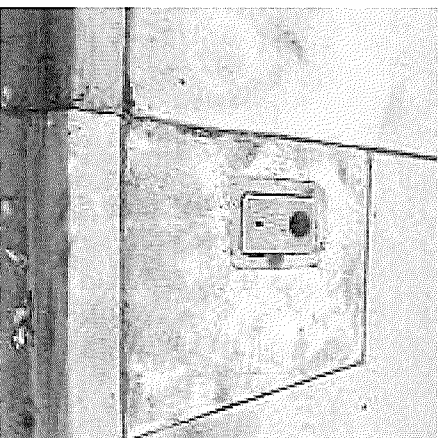

ATTACHMENT

4

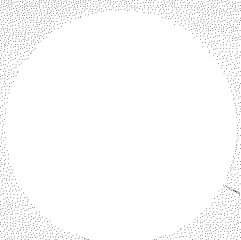

GARDEN GROVE

CITY OF GARDEN GROVE
UTILITY SERVICES DIVISION

11222 Acacia Parkway, Garden Grove, CA 92840

During Office Hours 714-741-5078 ~~415~~
After Hours 714-741-5704 (Police Dept.)

YOU CAN NOW PAY ONLINE.
<http://garden-grove.org/water>
OR PAY BY PHONE (888) 867-2992

HAVE YOU OVERLOOKED PAYING YOUR:

Water Bill Total Due: \$ _____ Including
\$ _____ Serv. Chg.
\$ _____ Turn On Chg.

Extension for water service has been granted until
Date: _____ at 5:00 p.m.

Water Service scheduled for shut-off on
Date: _____

- 48 Hr. Notice - Please Contact Office
- Returned Check - Cash/Money Order ONLY
- Unsigned Check
- Returned Mail
- Deposit
- Other - SEE REVERSE SIDE

NOTICE

In-person payments must be made **ONLY** at City Hall.
DO NOT MAIL OR PAY AT ANY OTHER LOCATION.
A night box is provided at the front of City Hall.

Water service will be restored:

- **Monday through Thursday and every other Friday between 8:30 a.m. and 5:30 p.m.** only upon payment of water bill.
- An additional \$100.00 will be charged for service after regular working hours and added to water account.

LOW FLOW INDICATOR IS MOVING
(See Attached Water Wisely Brochure)

CURRENT METER READ: _____
DATE: _____

METER TEST RESULTS: PASS / FAIL
DATE: _____

To avoid waste and excessive water usage, please read our *Water Wisely Brochure* that is attached.

WATER WAS TURNED OFF AT:

- House Valve – Water may be turned back on by turning the valve located just below the faucet at the front of the house.
- Water Meter – Please contact the office to have the water turned back on.

Per Municipal Code Sec. 14.020.050, it is unlawful for anyone other than employees of the Utilities division to turn water on at the meter. Water Meter checked daily if locked.

If any of the following have been tampered with, the following charges will be due and payable in 24 hours. If not paid, subject to Lock Off.

PENALTY CHARGES

____ Pull Meter	50.00
____ Reinstall Meter	50.00
____ Replace Angle Stop	100.00
____ TBO Fee for 2nd Lock Off	50.00
____ Padlock Charge	60.00

Water Conservation Tips

Don't Be a Water Waster! Follow these tips and help to save hundreds of gallons of water!

- 💧 Install a low-flow showerhead, then take only 5-minute showers or 3-inch baths.
- 💧 Install 1.6 gallon ultra-low-flush toilets, which can save 2 - 5 gallons per flush.
- 💧 Catch water in a bucket or watering can while waiting for it to get hot. Then use it on plants, or pour into toilet bowl to flush.
- 💧 Fix all leaky toilets, faucets, and pipes.
- 💧 Do not use the toilet to flush trash.
- 💧 Turn off the water when shaving, brushing teeth, lathering in the shower, washing dishes, or cleaning produce.
- 💧 Run only full loads in dishwashers and washing machines.
- 💧 Water your lawn no more than once a week and install a weather-based irrigation controller. Water outdoors in the early morning or evening.
- 💧 Use a bucket, sponge, and a hose with a shut-off valve, to wash your car.
- 💧 Sweep (never hose) your driveway, patio and sidewalk.

For more information on rebates for indoor and outdoor water-saving devices, please visit:

<https://gqcity.org/pw/water-rebates>

Make Every Drop Count

Water Used For Common Activities

Brushing teeth.....	3 gallons a day
Shower.....	40 gallons every 10 minutes
Bath.....	20 gallons
Toilet.....	28 gallons a day per person
Washing machine.....	45 gallons per load
Cooking.....	5 gallons per day
Dishwasher.....	15 gallons per load
Hosing driveway.....	150 gallons
Washing car.....	150 gallons

Not so common

Filling a swimming pool.....	20,000 - 25,000 gallons
------------------------------	-------------------------

Water Billing.....	(714) 741-5078, <i>Option #5</i>
Water Services.....	(714) 741-5395, <i>Option #3</i>
7:30 a.m. - 5:30 p.m.....	Mon. - Thurs.
7:30 a.m. - 5:00 p.m.....	Alternating Fridays
	Closed Alternating Fridays
Water Emergency Services	
After Hours.....	(714) 741-5704



City of Garden Grove
13802 Newhope Street
Garden Grove, CA 92843

Use Water Wisely

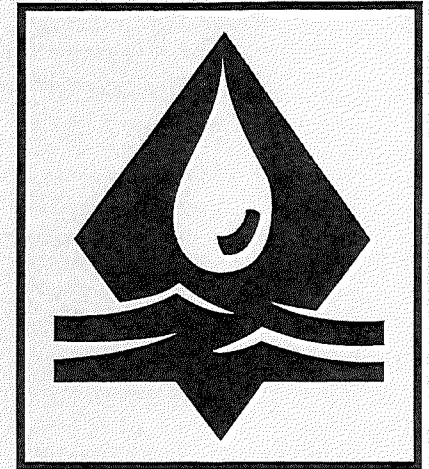

Provided as a public service by the City of Garden Grove Water Services Division

Reasons for a High Water Bill

From time to time, the City receives inquiries from customers because of, what appears to be, an unusually high water bill. The following are brief explanations of possible reasons for high water usage, all of which can, and do, contribute to widely fluctuating water bills.

A Little Costs A Lot!

Leaks in the plumbing; the number one reason for high water bills. Just a slow drip can add up to 20 gallons a day. The most common leaks are in the bathroom involving the flushing mechanisms within the toilet tanks. Check all faucets for leaks caused by worn washers. Leaks outside the house can be extremely wasteful, especially when they occur in the main water line. Have leaks repaired as soon as discovered.

Seasonal Increases

Water usage can increase during warmer and drier weather. During this time, most of the water piped into homes is directed back out through hoses onto lawns and gardens. When more water is used outside, the potential for wasted water is greater. High usage can be due to excessive watering of lawns and shrubs, or forgetting to turn off the water, sending it wastefully down the storm drains.

Reasons for a High Water Bill

- 1. Over watering your lawn**
750 - 1,500 gallons a month
- 2. Leaky faucets**
20 gallons a day for every leak
- 3. Running the hose while washing your car**
150 gallons a wash
- 4. High-flow showerhead**
500 - 800 gallons a month
- 5. Partial loads in the washing machine and dishwasher**
300 - 800 gallons a month
- 6. Long showers**
700 gallons a month
- 7. Hosing driveways and sidewalks**
150 gallons each time
600 gallons a month
- 8. Using toilet as a waste basket**
400 - 600 gallons a month
- 9. Letting tap water warm up without capturing any**
200 - 300 gallons a month
- 10. Sprinklers watering driveways, sidewalks or gutters**
500 gallons a month

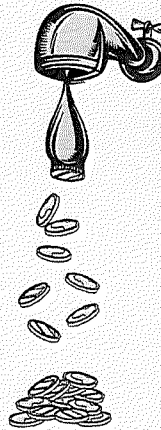

“Read Any Good Meters Lately?”

Our Meter Readers are responsible for reading approximately 500 meters per day. The meters are read with a computerized reading device which virtually eliminates reading errors.

If a potential reading error is detected in our control process, the meter is re-read.

“How Do I Read My Water Meter?”

To read the Direct-Read Dial, read from left to right. Record all numbers except the last two. For example, in this illustration, the reading would be 7452. Since water is billed by the unit (see Water Data), this means 7452 units of water have passed through the meter, and the difference between 7452 and the previous billing read is the current water usage.

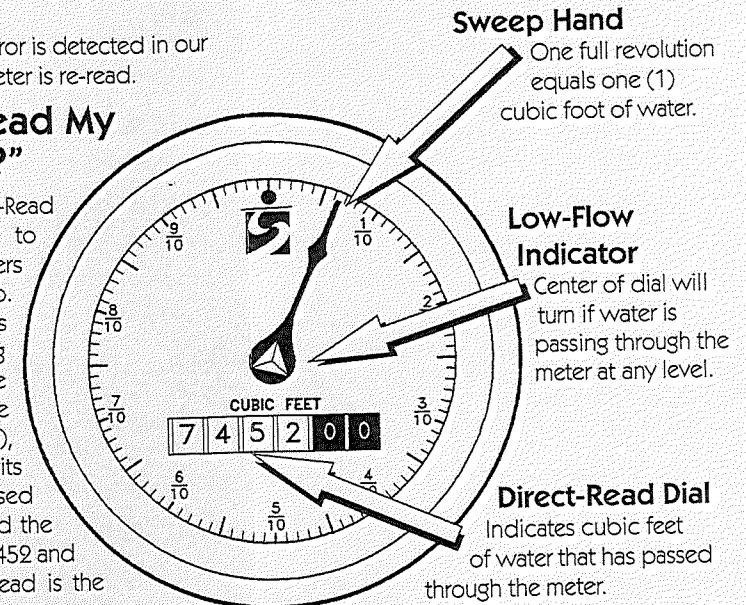

Water Data

100 cubic feet =	1 unit of water or 748 gallons
1 cubic foot =	7.48 gallons

“How Do I Know If I Have A Leak In My Plumbing?”

1. Turn off all water inside and outside your home. (Be sure the main house valve remains open.)
2. Observe your water meter. With the water off, the sweep hand and the low-flow indicator should remain stationary. If either are moving, water is passing through the meter, and you may have a leak in your plumbing.

Remember...

- It is the homeowner's responsibility to maintain a clean meter box.
- City water shut-off valves are not to be operated by anyone besides City personnel. If damaged, responsible party is liable for repairs/damages.

ATTACHMENT

5

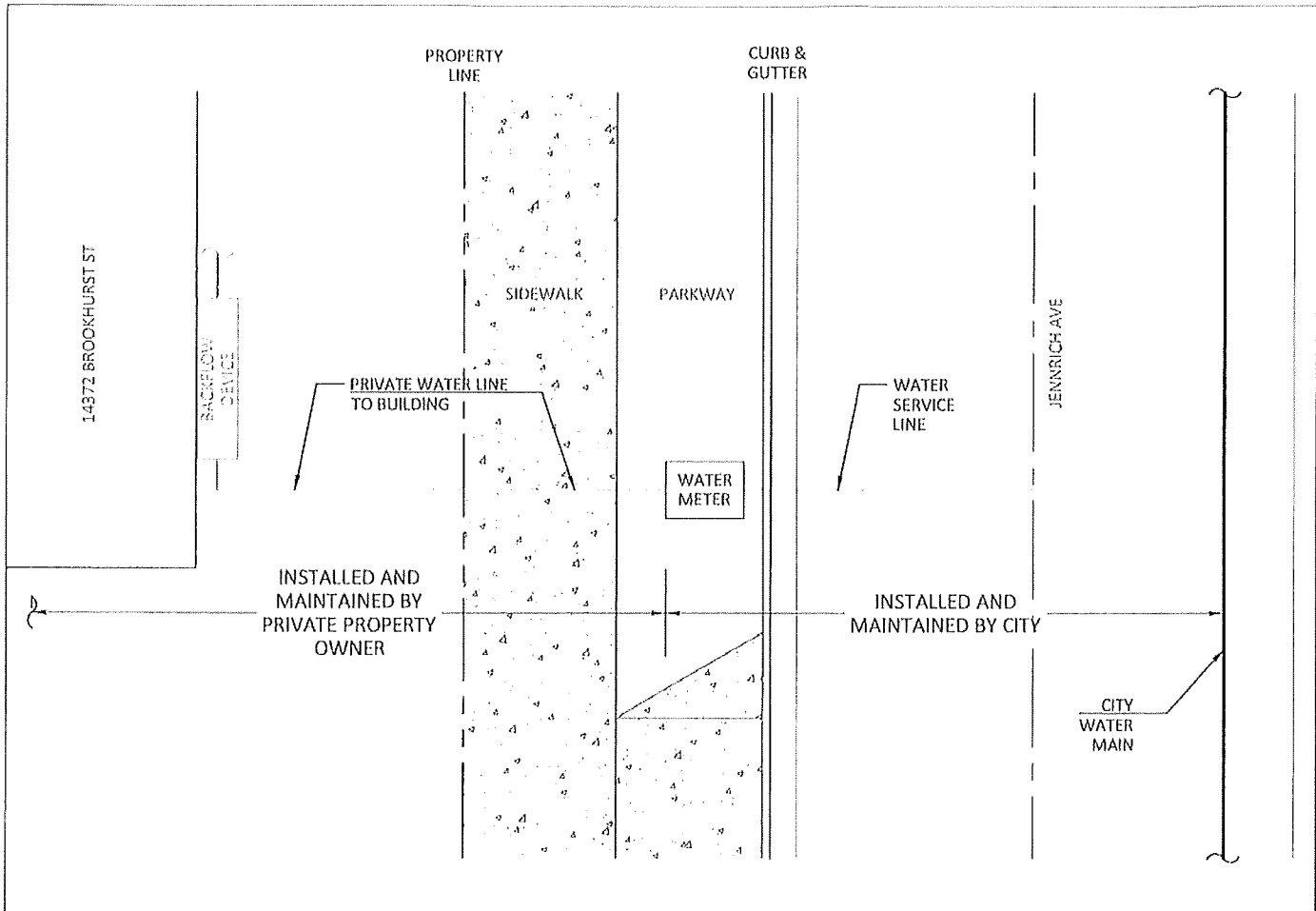

City of
Garden Grove
California

EXHIBIT 1
OWNER / CITY MAINTENANCE RESPONSIBILITY
FOR WATER SERVICE LINE

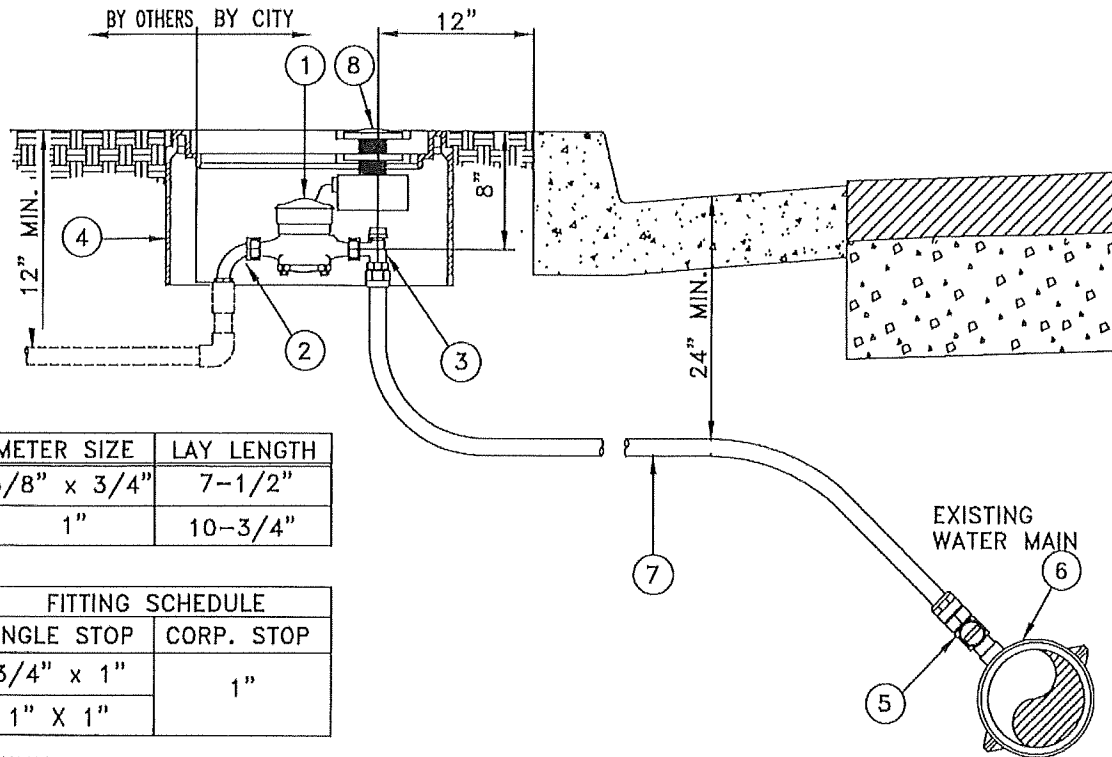

METER SIZE	LAY LENGTH
5/8" x 3/4"	7-1/2"
1"	10-3/4"

FITTING SCHEDULE	
ANGLE STOP	CORP. STOP
3/4" x 1"	1"
1" x 1"	

NOTES

1. ALL CITY SERVICES TO BE TYPE "K" SOFT COPPER.
2. TUBING TO BE ONE CONTINUOUS PIECE, NO SPLICES OR HEATING PERMITTED UNLESS APPROVED BY WATER SERVICES.
3. TAPS SHALL BE MADE AT LEAST 12" FROM ANY OTHER TAP OR COUPLING. STAGGER ANGLE OF TAPS MADE NEXT TO EACH OTHER 15°.
4. METER, METER BOX, ANGLE METER VALVE AND TAILPIECE, BY CITY AT CONTRACTOR'S EXPENSE, UNLESS OTHERWISE APPROVED.

MATERIAL LIST

ITEM NO.	QUAN.	DESCRIPTION	MFR.
①	1	5/8" OR 1" SMART METER	SENSUS, SRII
②	1	3/4" OR 1" ANGLE METER COUPLING	
③	1	3/4" x 1" OR 1" x 1" BALL ANGLE METER VALVE, COMPRESSION TYPE OR APPROVED EQUAL	MUELLER, JONES OR FORD
④	1	POLYMER METER BOX (DFW486WBC-12-1 OR APPROVED EQUAL)	DFW PLASTICS OR APPROVED EQUAL
⑤	1	1" CORPORATION STOP (COMPRESSION TYPE), BALL TYPE, C.C. THREAD	MUELLER, JONES OR FORD
⑥	1	SERVICE SADDLE DOUBLE STRAP (FORD 202BSD OR APPROVED EQUAL)	MUELLER, JONES OR FORD
⑦	AS NEEDED	1# SOFT COPPER TUBING, TYPE "K"	
⑧	1	FLEXNET SMARTPOINT 520M MODULE (OR APPROVED EQUAL)	SENSUS



**1" COPPER WATER SERVICE
INSTALLATION FOR 5/8" & 1" METERS**

Approved: *[Signature]* Date: 05-18-21
City Engineer R.C.E. 52125 Exp. 12-31-22

REVISIONS	BY	DATE	STD. PLAN NUMBER
			B-721
			SHEET 1 OF 1

ATTACHMENT

6

RESOLUTION NO. 002-2024

A RESOLUTION OF THE ADMINISTRATIVE BOARD OF APPEALS OF THE CITY OF GARDEN GROVE, CALIFORNIA, DENYING THE APPEAL OF EDGAR ROJAS OF THE GARDEN GROVE PUBLIC WORKS DIRECTOR'S DENIAL OF HIS REQUEST TO ADJUST WATER BILLS FOR ONE BILLING PERIOD FROM MARCH 23, 2023 TO MAY 18, 2023.

WHEREAS, Edgar Rojas ("Appellant") requested an adjustment to his water bill for one billing period from May 23, 2023 to May 18, 2023; and

WHEREAS, the Public Works Director denied Appellant's request and Appellant appealed the Director's decision on January 4, 2024; and

WHEREAS, on March 27, 2024, a hearing before the Administrative Board of Appeals of the City of Garden Grove was held at which the Administrative Board of Appeals considered testimony and evidence related to the Appellant's appeal of the Director's decision and continued the hearing to receive additional information requested by the Board; and

WHEREAS, Appellant and all other persons with an interest in the subject matter of the appeal were afforded an opportunity to be heard and present evidence to the Administrative Board of Appeals of the City of Garden Grove at its March 27, 2024 hearing.

NOW, THEREFORE, THE ADMINISTRATIVE BOARD OF APPEALS OF THE CITY OF GARDEN GROVE, CALIFORNIA, DOES RESOLVE, DECLARE, DETERMINE, AND ORDER AS FOLLOWS:

SECTION 1. The Administrative Board of Appeals of the City of Garden Grove hereby makes the following findings of fact:

1. The City was formally informed of a high water bill from Appellant on May 26, 2023 regarding a higher than normal water use after receiving a bill for the period of May 23, 2023 to May 18, 2023, in the amount of \$928.05 for the use of 191 units (approximately 3.41 units per day).
2. On January 23, 2023, City staff read the meter and verified that the low flow indicator was moving, indicating a leak at Appellant's property. A water wise brochure and door hanger was placed that references "low flow indicator is moving" and the current read.
3. On March 28, 2023, City staff was conducting routine meter reading and noticed the low flow indicator was moving indicating a continuing leak.
4. The bill was inadvertently generated at 2 units, in which it should have been at 109 units billed during the period from January 17, 2023 to March 23, 2023. The previous billing units of 109 were combined with the billing units of 82 within the billing period from March 23, 2023 to May 18, 2023, for a total of 191 units for a four month period.

5. City staff performed a re-read of the meter on May 23, 2023 and confirmed a high water usage.
6. On May 26, 2023, Mr. Rojas made initial contact with the City requesting a re-read of the water meter due to a higher than normal water use after receiving a bill for the period of March 23, 2023 to May 18, 2023, in the amount of \$928.05 for the use of 191 units (approximately 3.41 units per day).
7. City staff responded on May 26, 2023 and confirmed that there was no leak from and around the meter.
8. On June 6, 2023, City staff informed Mr. Rojas of the billing cycle error and the account correction took place, as outlined above.
9. On September 15, 2023, the City performed an in ground meter test for meter accuracy and it passed.
10. On December 8, 2023, City staff removed the old water meter and replaced it permanently with a new water meter. The old water meter was tested by Westerly on December 11, 2023. The test results showed that the old meter was under registering water flow to the customer's benefit.
11. The Appellant did not provide evidence that he or a third-party professional conducted an investigation or evaluation showing the nonexistence of water leaks on the water facilities on Appellant's property.
8. The Public Works Director correctly denied the Appellant's request to adjust and reduce its water bills.

SECTION 2. Based on the findings of fact referenced herein and after consideration of all relevant testimony and evidence submitted at the March 27, 2024 meeting of the Administrative Board of Appeals of the City of Garden Grove, the decision of the Public Works Director denying Appellant's request for billing adjustments is hereby affirmed, and the appeal filed by Edgar Rojas on January 4, 2024, is hereby denied.

SECTION 3. The Building Official is directed to provide notice of the decision of the Administrative Board of Appeals and of this Resolution to Appellant, Edgar Rojas within seven (7) days of the date this Resolution is adopted.

SECTION 4. This Resolution shall become final effective immediately.

Adopted this 27th day of March, 2024.

ATTEST:

CHAIR

SECRETARY

STATE OF CALIFORNIA)

COUNTY OF ORANGE) SS:
CITY OF GARDEN GROVE)

I, JUDITH MOORE, Secretary of the City of Garden Grove Administrative Board of Appeals, do hereby certify that the foregoing Resolution was duly adopted by the Administrative Board of Appeals of the City of Garden Grove, California, at a Special Meeting held on the 27th day of March, 2024, by the following vote:

AYES: BOARD MEMBERS:
NOES: BOARD MEMBERS:
ABSTAIN BOARD MEMBERS:
ABSENT: BOARD MEMBERS:

SECRETARY

PLEASE NOTE: Any request for court review of this decision must be filed within 90 days of the date this decision was final (See Code of Civil Procedure Section 1094.6).

City of Garden Grove

INTER-DEPARTMENT MEMORANDUM

To: Garden Grove Administrative Board of Appeals From: William E. Murray, P.E.
Public Works Director

Subject: February 1, 2024 Appeal of Water Bills for 13349 Ramona Drive Date: March 27, 2024

REQUEST

Appellant, Ngan Nguyen (hereinafter "Mr. Nguyen" or "Appellant"), requests that the Administrative Board of Appeals (the "Board") approve their appeal of the water billing for one billing periods from November 13, 2023 to January 17, 2024 (the "Appeal") filed on February 1, 2024, for property located on 13349 Ramona Drive (See, Attachment 1). The appeal seeks a reduction of the amount of this billing period.

JURISDICTION

Garden Grove Municipal Code section 14.12.070 authorizes the Board to hear appeals of the decision of the Public Works Director denying a request for an adjustment to a water bill as provided below.

- In the event of any dispute as to a charge to a customer, the Public Works Director or designee shall determine if the City is responsible. If, in the determination of said Director, the City is adjudged to be responsible, the Public Works Director may adjust the charge. If, in the determination of the Director, the responsibility is determined to be other than the City, no adjustment shall be granted. After the receipt of the decision of the Public Works Director regarding the responsibility of the disputed charge, the customer shall have the right to file an appeal of such determination within 15 days. The Administrative Board of Appeals shall consider the appeal and the report of the Director regarding the circumstances of this determination. The Board shall decide whether or not to grant an adjustment and the decision of the Board in respect thereto shall be final and conclusive.
- Pursuant to Code of Civil Procedure Section 1094.6, any petition for judicial review shall be filed not later than 90 days after the Board makes its final decision. The provisions of Section 1094.6 shall apply. The secretary of the Board shall notify the appellant that filing a petition for an administrative writ is subject to the 90-day time limitation set forth in Code of Civil Procedure Section 1094.6.

HEARING PROCEDURE

Resolution No. 001-13, which was adopted by the Board on October 16, 2013, pursuant to the authority granted by Garden Grove Municipal Code section 2.54.060, governs the conduct of appeals before the Board. According to the procedures adopted by the Board, appeal hearings shall follow the following format:

- i. Open Hearing
- ii. Presentation by City
- iii. Presentation by Appellant
- iv. Testimony of members of the public opposing administrative decision being appealed from (if any)
- v. Testimony of members of the public supporting administrative decision being appealed from (if any)
- vi. Appellant's rebuttal (limited to addressing points raised by opposition and answering Board's inquiries)
- vii. Close Hearing
- viii. Board discussion and vote.

With respect to the City's presentation, Resolution No. 001-13 states that the City shall have the initial burden to establish that the Appeal is supported by evidence and regulatory authority for the decision. (Resolution 001-13 § i) The City's Appeal and any documentary evidence submitted by the City at the hearing constitutes prima facie evidence of the facts stated in those documents, and support for the Appeal if they (1) describe the conditions, acts or omissions upon which the Appeal was based, (2) set forth the regulatory authority for the Appeal and (3) establish facts supporting the Appeal. (Resolution 001-13 § i)

Upon a showing by the City that the Appeal is supported by evidence and regulatory authority, the burden shifts to the Appellant to establish that (1) the true intent of the municipal code or the rules legally adopted thereunder were incorrectly interpreted by the Public Works Director or designee in issuing the Appeal, (2) that the provisions of the municipal code do not fully apply to the issue addressed by the Appeal, or (3) that "the requirements of the municipal code are adequately satisfied by other means."

The Board then may consider any other relevant evidence on the appeal from any member of the public whose interests are affected by the issue on appeal. Upon conclusion of the presentations by the City, Appellant, and any other interested persons, the Board shall close the hearing on the matter, conduct discussion amongst the members of the Board, and hold a vote regarding the merits of the appeal.

BACKGROUND

The City manages a water system that covers 17.8 square miles and provides safe, clean drinking water to approximately 34,300 water customers. The City recognizes that the leaks in private systems can cause a significant financial burden from

unexpected water usage. City has processes and policies to help with investigating high water bills. The process involves the following:

- Billing system review and reading of account
- Physical inspection and reading of the meter on site, if necessary.
- Provide third party meter testing, upon request.
- Communication of findings to customer.

On February 1, 2024, the City received a timely notice of appeal and request for an Administrative Board of Appeals hearing from Mr. Nguyen (See, Attachment 1) The Appeal alleges (1) a defective water meter that affects the customer's measured consumption should be fixed by City personnel (2) a high water bill resulting from a defective water meter should be credited during billing period from November 13, 2023 to January 17, 2024 (3) two plumber inspections conducted on January 29, 2024 and January 31, 2024, indicating no leak present at that time.

On January 22, 2024, City was conducting routine meter reading and noticed the low flow indicator was moving which indicates a possible leak. City staff verbally notified the resident of potential leak in English and translated in Vietnamese over the phone. City staff re-read the meter and confirmed low flow indicator was moving. City staff spoke with occupant and was informed two toilets had been leaking last month and had recently been fixed. On January 29, 2024, Mr. Nguyen made initial contact with the City to inform the City of a higher than normal water use after receiving a bill for the period of November 13, 2023 to January 17, 2024, in the amount of \$5,122.29 for the use of 967 units (approximately 14.88 units per day). Mr. Nguyen also provided two plumber's invoice inspection reports showing no leak. One inspection report was received from Joseph's Plumbing & Rooter, dated January 29, 2024. The second inspection report was received on January 31, 2024, invoice #138676591. City staff scheduled an in ground meter test to be performed on January 31, 2024 at 9:57am. On that day, City staff was unable to perform the test due to the low flow indicator moving. City staff verbally notified the resident of a potential leak.

On February 7, 2024, City staff removed the old water meter and replaced it permanently with a new water meter. Old water meter was tested by Westerly on February 8, 2024. The test results passed, according to the American Water Works Association standards. Mr. Nguyen has not paid for the high water billing period in the amount of \$5,122.29 until this Appeal is resolved.

It is the City's responsibility to maintain the water meter up to the City-side and it is the water customer's responsibility for investigating and repairing any leaks attributed to the customer-owned side of the water meter. Common factors for customer-side leaks: irrigation leaks, internal plumbing leaks, theft, vandalism, negligence by occupants. Upon City staff's review, Mr. Nguyen's occupant communicated to the City "good faith" efforts on their part in regard to informing the City of two leaking toilets that were repaired. Leaking toilets can lead to water loss of over 600 gallons to 1,000 gallons per billing period, depending on the severity of

the leak. Mr. Nguyen communicated to the City "good faith" efforts on their part in regard to performing independent investigations. However, the plumber reports are irrelevant evidence due to the inspections taking place after the billing period from November 13, 2023 to January 17, 2024. This is a single family resident unit with a one, 5/8" X 3/4 " inch, water meter providing water service to 1 unit.

Mr. Nguyen received a bill for the period of November 13, 2023 to January 17, 2024, the total water use amounted to 967 units (approximately 14.88 units per day). City staff has concluded that this temporary increase in water consumption may have been due to leaks from the two toilets on the property owner's side of the water system mentioned above, outside of the City's responsibility.

The City maintains the city-side of the water meter and the property owner is responsible for maintenance of their pipes and water usage on their side of the water meter. There was no water leak at the City's side of the meter. Therefore, the water usage during the specified one billing period are attributed to a private property related issue and the City should not be required to reduce the billing in question.

CITY STAFF'S EVIDENCE

In support of the City's effort to determine whether the City's meter was the cause of the increased water usage at the Appellant's property, Attachment 2 shows that the third-party Test Certification for the replaced meter indicates that the meter test results passed, according to the American Water Works Association standards. This means that the meter was working properly for the Appellant. The meter was therefore not the cause of the increased billing amounts.

Attachment 3 are the service requests indicating that the City made contact with the Appellant and inspected the meter on January 22, 2024, January 31, 2024 and replaced it on February 7, 2024, with a new meter. The old meter passed testing and was not deemed defective.

Attachment 4 shows the boundaries of the City's water system responsibility. City staff is not able to inspect or examine the private water lines and facilities on Appellant's private property, where leaks or increased water usage would have caused higher water bills.

Finally, the Appellant's occupant has provided the City information showing that it increased consumption from two toilet leaks took place during the contested billing period. The Appellant provided two professional plumber inspections of the Appellant's water facilities and water usage and found no problems that is outside of the contested billing period. It should not be sufficient for Appellant to argue that it is not responsible for increased water usage simply because the increase is not typical of their historical water usage.

RECOMMENDATION

Based on the foregoing, City staff recommends that the Board make the following findings of fact:

1. The City was formally informed of a high water bill from Ngan Nguyen on February 1, 2024 regarding a higher than normal water use after receiving a bill for the period of November 13, 2023 to January 17, 2024, in the amount of \$5,122.29 for the use of 967 units (approximately 14.88 units per day).
2. On January 22, 2024 and January 31, 2024, the City investigated the water meter as the cause of increased water billing.
3. On February 7, 2024, existing water meter was replaced with a new water meter and old meter was passed accuracy test.
4. The Appellant did not provide relevant evidence that its employees or a third-party professional conducted an investigation or evaluation showing the nonexistence of water leaks on the water facilities on Appellant's property. Evidence was provided by its occupants, indicating two toilet leaks resulting from increase in their water consumption.
5. The Public Works Director correctly denied the Appellant's request to adjust and reduce its water bills.

Further, staff recommends that the Board adopt the attached Resolution (Attachment 5) containing the findings outlined above, and denying Ngan Nguyen February 1, 2024 appeal.

 for WEM

WILLIAM E. MURRAY, P.E.
Public Works Director

Attachments:

- 1) February 1, 2024 Notice re Water Billing Appeal, 13349 Ramona Drive Garden Grove, CA
- 2) Water Meter Accuracy Test Conducted on February 8, 2024
- 3) Workorders: January 22, 2024, January 31, 2024, February 7, 2024
- 4) Diagram
- 5) Resolution #003-2024

ATTACHMENT

1



CITY OF GARDEN GROVE
REQUEST FOR ADMINISTRATIVE BOARD OF APPEALS HEARING

RECEIVED
CITY OF GARDEN GROVE
CITY CLERK'S OFFICE
2024 JAN 32 AM 11:31

- Water Billing Appeal
- Notice and Order

TO: City Clerk's Office, City of Garden Grove
11222 Acacia Parkway, Garden Grove, CA 92840
(714) 741-5040

FILING FEE: \$225.00

Pursuant to Municipal Code Section 2.54.110, this appeal form must be filed with the City Clerk's Office within 15 days from the date of determination for water billing disputes, or 15 days from the date of service of the notice and order being appealed.

Appellant(s):

NGAN NGUYEN

Address(es) or legal description:

13349 RAMONA DR
GARDEN GROVE, CA 92843

Describe legal interest of each appellant (indicate if building, land, or both):

DISPUTE \$5,122.99 WATER BILL OF RESIDENTIAL HOME

State the specific order or action protested:

PROTEST \$5,122.99 WATER BILL OF RESIDENTIAL HOME WITHOUT SWIMMING POOL DUE TO FAULTY WATER METER

State the relief sought and reasons why the protested order or action would be reversed, modified, or otherwise set aside. Present material facts to support your contentions (use additional paper if necessary):

PLEASE REVIEW THE WATER METER READING BECAUSE \$5,122.99 WATER BILL IS UNREASONABLE FOR THE WATER LEAK. WE ATTACH THE COPIES OF 2 PLUMBER REPORTS AND THE HISTORY OF WATER BILLING CYCLE. THANK YOU

I hereby certify under penalty of perjury that the statements contained in this appeal to be the truth to the best of my knowledge.

Appellant(s): NGAN NGUYEN

Address, City, ZIP: 13349 RAMONA DR GARDEN GROVE, CA 92843

Phone No.: (714) 400-7801

Signature of at least one Appellant:

Date:

2/1/2024

TITLE 2: CHAPTER 54: ADMINISTRATIVE BOARD OF APPEALS

SECTION 2.54.010: Creation

There is created an Administrative Board of Appeals for the City, hereinafter referred to as the "Board," the function of which will be to perform the duties provided in this chapter. (2813 § 1, 2012; 1317 § 1, 1973).

SECTION 2.54.020: Composition

The Board shall consist of five (5) members who are qualified by experience and training to pass upon matters pertaining to building construction, or fire protection, or standard waterworks practices. Preference in the selection of the members of the Board shall be given to those individuals who possess state licenses or certificates in the field of engineering, construction, or related professions or trades. (2813 § 1, 2012; 1317 § 1, 1973).

SECTION 2.54.030: Appointment of Members

The members of the Appeal Board shall be residents and qualified electors, and the Building Official shall act as secretary of the Board. (2813 § 1, 2012; 1628 § 26, 1977; 1317 § 1, 1973).

SECTION 2.54.050: Meetings and Quorum

The Board shall meet when called by the Building Official. Within not less than ten (10) nor more than sixty (60) days of receipt of an appeal request from any person who is authorized to make appeal to such Board, the Building Official shall call and give notice of the time, date, and place of such meeting. Three (3) members shall constitute a quorum. (2813 § 1, 2012; 1817 § 1, 1983; 1677 § 1, 1978; 1317 § 1, 1973).

SECTION 2.54.060: Board Operating Procedure

The Board shall, from time to time, establish the procedures for the conduct of its meetings and such procedures shall be established by resolution and may be amended by the same method. (2813 § 1, 2012; 1317 § 1, 1973).

SECTION 2.54.080: Duties

The Board shall provide final City interpretation of the provisions of various City codes and ordinances where so authorized, and further, to conduct hearings to determine the suitability of alternate material and types of construction under the ordinances. (2813 § 1, 2012; 1317 § 1, 1973).

SECTION 2.54.090: Filing Fee

In order to cover the administrative costs of processing applications for appeals, there shall be submitted an application fee established by City Council resolution. (2813 § 1, 2012; 2290 § 1 (1), 1994; 1317 § 1, 1973).

SECTION 2.54.100: Time to Appeal

Unless otherwise provided by ordinance, any party desiring to make use of the Board in accordance with the provisions contained within this chapter and for the purposes authorized by codes and ordinances adopted by the City shall commence the appeal no later than fifteen (15) days following an adverse determination by the City official responsible for administering such code or ordinance. (2813 § 1, 2012; 1317 § 1, 1973).

SECTION 2.54.110: Place of Appeal

Each appeal filed under the provisions of this chapter shall be on a form provided by the City Clerk's Office and shall be filed with the City Clerk within the time provided herein. The Board shall commence a hearing on the appeal no later than sixty (60) days following the filing of same. (2813 § 1, 2012; 1317 § 1, 1973).

TITLE 14: CHAPTER 12: WATER RATES

SECTION 14.12.070: Water Billing Appeals

A. In the event of any dispute as to a charge to a customer, the Public Works Director or designee shall determine if the City is responsible. If, in the determination of said Director, the City is adjudged to be responsible, the Public Works Director may adjust the charge. If, in the determination of the Director, the responsibility is determined to be other than the City, no adjustment shall be granted. After the receipt of the decision of the Public Works Director regarding the responsibility of the disputed charge, the customer shall have the right to file an appeal of such determination within 15 days. The Administrative Board of Appeals shall consider the appeal and the report of the Director regarding the circumstances of this determination. The Board shall decide whether or not to grant an adjustment and the decision of the Board in respect thereto shall be final and conclusive.

B. Pursuant to Code of Civil Procedure Section 1094.6, any petition for judicial review shall be filed not later than 90 days after the Board makes its final decision. The provisions of Section 1094.6 shall apply. The secretary of the Board shall notify the appellant that filing a petition for an administrative writ is subject to the 90-day time limitation set forth in Code of Civil Procedure Section 1094.6. (2917 § 1, 2020; 2811 § 1, 2012; 1068 § 10, 1969; 983 § 1, 1968; 630 § 1, 1963; prior code § 7330.7).

Customer

 Print Bill

Name: NGUYEN, NGAN
(300255007)
Address: 13349 RAMONA DR, Garden
Grove, CA 92843-2642
Phones: 714-723-1842 WK

Service

Estimated Next Read: 03/15/2024
Service at: 13349 RAMONA DR
Service id: 30025500 Housing units: 1
Current read: 3517 Service type: Single family home
Rate type: Metered Meter size: 5/8"x3/4"
Meter serial: 73549200 Meter installed: 03/02/2012

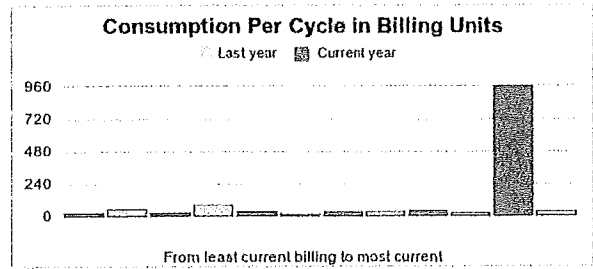

05/26/09	07/21/09	56	~3355	36	0.64
03/30/09	05/26/09	57	~3319	35	0.61
01/30/09	03/30/09	59	~3284	28	0.47
11/25/08	01/30/09	66	~3256	28	0.42
09/30/08	11/25/08	56	~3228	36	0.64
08/04/08	09/30/08	57	~3192	42	0.74
06/06/08	08/04/08	59	~3150	45	0.76
04/10/08	06/06/08	57	~3105	38	0.67
02/13/08	04/10/08	57	~3067	30	0.53
12/10/07	02/13/08	65	~3037	29	0.45
10/12/07	12/10/07	59	~3008	37	0.63
08/16/07	10/12/07	57	~2971	42	0.74
06/20/07	08/16/07	57	~2929	45	0.79
04/24/07	06/20/07	57	~2884	41	0.72
02/27/07	04/24/07	56	~2843	39	0.70
12/21/06	02/27/07	68	~2804	35	0.51
10/25/06	12/21/06	57	~2769	40	0.70
08/29/06	10/25/06	57	~2729	53	0.93
07/03/06	08/29/06	57	~2676	47	0.82
05/04/06	07/03/06	60	~2629	48	0.80
03/09/06	05/04/06	56	~2581	32	0.57
01/11/06	03/09/06	57	~2549	33	0.58
11/04/05	01/11/06	68	~2516	38	0.56
09/09/05	11/04/05	56	~2478	44	0.79
07/14/05	09/09/05	57	~2434	65	1.14
05/17/05	07/14/05	58	~2369	38	0.66

Account

date	type	amount	balance
01/22/24	Sewer Service Charge	26.68	5,122.29
01/22/24	Water Tier 1 33@3.4	112.20	5,095.61
01/22/24	Water Tier 2 934@5.29	4,940.86	4,983.41
01/22/24	Water Service Charge	35.10	42.55
01/22/24	Water Capital Improvement	7.45	7.45
01/22/24	BILLING	5,122.29	
12/04/23	PAYMENT	-247.11	0.00
11/16/23	Sewer Service Charge	26.68	247.11
11/16/23	Water Tier 1 33@3.26	107.58	220.43
11/16/23	Water Tier 2 15@4.8	72.00	112.85

10/20/16	12/21/16	62	840	36	0.58
08/23/16	10/20/16	58	804	35	0.60
06/28/16	08/23/16	56	769	28	0.50
05/02/16	06/28/16	57	741	32	0.56
03/02/16	05/02/16	61	709	28	0.46
01/11/16	03/02/16	51	681	19	0.37
10/29/15	01/11/16	74	662	29	0.39
09/01/15	10/29/15	58	633	25	0.43
07/07/15	09/01/15	56	608	24	0.43
05/07/15	07/07/15	61	584	23	0.38
03/16/15	05/07/15	52	561	26	0.50
01/19/15	03/16/15	56	535	28	0.50
11/07/14	01/19/15	73	507	29	0.40
09/11/14	11/07/14	57	478	29	0.51
07/16/14	09/11/14	57	449	30	0.53
05/21/14	07/16/14	56	419	30	0.54
03/25/14	05/21/14	57	389	30	0.53
01/28/14	03/25/14	56	359	23	0.41
11/19/13	01/28/14	70	336	31	0.44
09/19/13	11/19/13	61	305	33	0.54
07/23/13	09/19/13	58	272	33	0.57
05/29/13	07/23/13	55	239	30	0.55
04/02/13	05/29/13	57	209	28	0.49
02/04/13	04/02/13	57	181	24	0.42
11/28/12	02/04/13	68	157	24	0.35
10/01/12	11/28/12	58	133	24	0.41
08/01/12	10/01/12	61	109	29	0.48
06/06/12	08/01/12	56	80	31	0.55
04/10/12	06/06/12	57	49	30	0.53
02/14/12	04/10/12	56	19	27	0.48
12/08/11	02/14/12	68	3886	29	0.43
10/13/11	12/08/11	56	3857	37	0.66
08/17/11	10/13/11	57	3820	36	0.63
06/22/11	08/17/11	56	3784	32	0.57
04/22/11	06/22/11	61	3752	36	0.59
02/28/11	04/22/11	53	3716	30	0.57
12/28/10	02/28/11	62	3686	32	0.52
10/26/10	12/28/10	63	3654	28	0.44
08/31/10	10/26/10	56	3626	37	0.66
07/06/10	08/31/10	56	3589	39	0.70
05/06/10	07/06/10	61	3550	32	0.52
03/11/10	05/06/10	56	3518	32	0.57
01/14/10	03/11/10	56	3486	26	0.46
11/12/09	01/14/10	63	3460	32	0.51
09/16/09	11/12/09	57	~3428	30	0.53
07/21/09	09/16/09	57	~3398	43	0.75

Base Consumption Summary:

Cons:		start	end	days	read	units	per day
year	cons						
2023	25	11/13/23	01/17/24	65	3517	967	14.88
2022	36	09/13/23	11/13/23	61	2550	48	0.79
2021	28	07/17/23	09/13/23	58	2502	38	0.66
2020	38	05/16/23	07/17/23	62	2464	40	0.65
2019	39	03/21/23	05/16/23	56	2424	31	0.55
2018	30	01/12/23	03/21/23	68	2393	34	0.50
2017	28	10/31/22	01/12/23	73	2359	44	0.60
2016	23	08/29/22	10/31/22	63	2315	29	0.46
2015	23	06/29/22	08/29/22	61	2286	38	0.62
2014	24	05/05/22	06/29/22	55	2248	25	0.45
2013	24	03/09/22	05/05/22	57	2223	94	1.65
2012	29	01/18/22	03/09/22	50	2129	60	1.20
2011	26	11/04/21	01/18/22	75	2069	66	0.88
2010	28	09/09/21	11/04/21	56	2003	44	0.79
2009	28	07/13/21	09/09/21	58	1959	48	0.83
2008	29	05/14/21	07/13/21	60	1911	44	0.73
2007	32	03/22/21	05/14/21	53	1867	36	0.68
2006	33	01/22/21	03/22/21	59	1831	36	0.61
2005	33	11/16/20	01/22/21	67	1795	38	0.57
		09/17/20	11/16/20	60	1757	38	0.63
		07/21/20	09/17/20	58	1719	37	0.64
		05/26/20	07/21/20	56	1682	37	0.66
		03/31/20	05/26/20	56	1645	28	0.50
		01/30/20	03/31/20	61	1617	33	0.54
		11/26/19	01/30/20	65	1584	38	0.58
		09/26/19	11/26/19	61	1546	41	0.67
		08/01/19	09/26/19	56	1505	44	0.79
		06/04/19	08/01/19	58	1461	45	0.78
		04/10/19	06/04/19	55	1416	40	0.73
		02/07/19	04/10/19	62	1376	43	0.69
		12/03/18	02/07/19	66	1333	40	0.61
		10/04/18	12/03/18	60	1293	39	0.65
		08/09/18	10/04/18	56	1254	41	0.73
		06/13/18	08/09/18	57	1213	39	0.68
		04/18/18	06/13/18	56	1174	39	0.70
		02/15/18	04/18/18	62	1135	43	0.69
		12/11/17	02/15/18	66	1092	42	0.64
		10/11/17	12/11/17	61	1050	38	0.62
		08/15/17	10/11/17	57	1012	36	0.63
		06/20/17	08/15/17	56	976	30	0.54
		04/25/17	06/20/17	56	946	34	0.61
		02/28/17	04/25/17	56	912	33	0.59
		12/21/16	02/28/17	69	879	39	0.57



AMERICAN LEAK DETECTION

THE ORIGINAL LEAK SPECIALISTS™

American Leak Detection
910 E. Orangefair Ln,
Anaheim CA 92801
Ph (714) 836-8477
Fx (714) 836-9948
www.americanleakdetection.com
TAX ID: 33-0744492

Claim #/PO #
Invoice 138676591
Invoice Date 1/31/2024
Completed Date 1/31/2024

Billing Address
Duke Tran
13349 Ramona Drive
Garden Grove, CA 92843 USA
: (714) 400-7801
duker17b54@yahoo.com

Job Address
Duke Tran
13349 Ramona Drive
Garden Grove, CA 92843 USA

Description of Work

Task #	Description	Total
R-	#138676591 Date: 1/31/24 Residential Slab Detection	\$325.00
SLAB	Roman, Osvaldo, and Gabriel arrived onsite and performed a complete leak detection of the cold and hot water system and the main water line from the meter to the front of the house finding all the lines to be secure and leak free at this time. The technician performed a meter test and no meter movement was detected. The technician also pressure tested the water system and no pressure was lost indicating no leaks. (GP) For any technical questions please contact the technician Roman at 714-412-1151. For administrative assistance please contact the office at (714) 836-8477.	

Paid On	Type	Memo	Amount
1/31/2024	Cash Collection		\$325.00
		Sub-Total	\$325.00
		Tax	\$0.00
		Total Due	\$325.00
		Payment	\$325.00
		Balance Due	\$0.00

THANK YOU FOR CHOOSING AMERICAN LEAK DETECTION.

****Notice to Property Owner:** If your correct insurance company information has been provided (see Other Account Information above), a copy has been forwarded to them. Please follow up with your insurance company to ensure payment and file this copy for your records. Please understand that if your insurance company does not pay, ultimate responsibility for payment resides with you as the property owner.

Contractors are required by law to be licensed and regulated by the Contractor's State License Board. Any questions concerning a contractor may be referred to the Registrar, Contractors State License Board, 9835 Goethe Road, Sacramento, CA 95827. Mailing Address: P.O. Box 26000, Sacramento, CA 95826.

GUARANTEE ON DETECTIONS: All leak locations and detection work is guaranteed for 30 days from the date of completion. We will re-test the system if it is reported within the above 30 day period that a leak still exists. American Leak Detection will not be liable for any consequential losses arising from inaccurate location in excess of the fee paid.

GUARANTEE ON REPAIRS: Minor repairs made by American Leak Detection are guaranteed for 30 days. Major repairs are guaranteed for 5 years. Warranties are non transferrable. All repairs are guaranteed from date of completion for defects in workmanship only. IF ANY UNFORESEEN CIRCUMSTANCES ARISE DURING THE REPAIR PROCESS A CHANGE ORDER WILL BE WRITTEN.

NOTE: All repairs made by American Leak Detection include retesting for further leakage at no additional charge. Repairs made by others can be retested upon request. The testing will carry a minimum \$200 service charge.

PIPE CONDITION: If the pipe material is found to be in an advanced state of deterioration when exposed for line repair, this does not represent a breach of contract by American Leak Detection nor does it negate the client's responsibility to pay for said services. Fees for opening and closing the slab will still be due, even if a re-route is determined to be necessary.

American Leak Detection (ALD) is the leading leak detection company in the nation and we will, at all times, make every effort to accurately locate your leak(s) and ensure your complete satisfaction. However, leak detection is not an exact science and consequently, due to the numerous factors, known and unknown, involved in locating leaks, there will be times when the location of a leak is incorrectly identified. Most leaks will be located within several inches of their exact location but this can vary to within several feet, depending on soil conditions, construction methods, and other factors, known and unknown. ALD will not be responsible, financial or otherwise, for the possible inaccurate location of leaks due to the aforementioned known and unknown factors.

Due to the fact that in most cases only one leak can be located at a time on any particular plumbing line, it is very important that the system is rechecked after repairs have been completed. ALD cannot guarantee that additional leaks do not exist or that the identified leaks will not re-occur. Should the rare situation occur that we could not locate a leak that exists, we will attempt to provide you with the best alternatives to resolve the situation.

While performing leak detection tests our technicians may need to disconnect and remove toilets, turn off supply lines valves, isolation valves, water heaters, etc. In some cases, where these items have not been touched or manipulated in a long time, they may break and/or begin to leak. Also, in order for us to find and/or confirm some leaks it may be necessary for our technicians to cut holes in walls, pull back carpeting, etc. Our technicians may also be inserting video cameras, inflatable test balls, line tracing devices and various other pieces of equipment into the sewer and waste lines, in order to determine the location of the lines and leaks that may exist therein. At times these pieces of equipment can become lodged in a line and be irretrievable without digging up and cutting the line. All of these items are considered necessary for us to be able to perform the tasks we have been hired to do. ALD will not be responsible for any unavoidable or necessary collateral damage to property such as toilets and their components, shut-off valves, water heaters, sheet rock, sheer wall, tile/flooring, carpeting, etc., or for items getting lodged in the lines. ALD assumes no responsibility for the replacement cost thereof.

ALD is authorized to make opening(s) on-site as deemed necessary to test, access and repair but not responsible for restoration (roof, ceiling, drywall, stucco, paint, wallpaper, carpet, linoleum, ceramic tile, marble/granite, cabinet, wood panel/floor, bricks, landscaping, pool plaster, matching concrete, salt washing, etc). ALD will not be responsible for any damage to unmarked underground pipes or utilities. ALD assumes no responsibility for damage to a radiant heat system or boiler if the system is turned on or operated without the following the recommended precautions.

Asbestos and Mold Release. American Leak Detection makes no representation or warranty, express, implied, or otherwise regarding asbestos, mold, fungi, rust, corrosion or other bacteria or organisms. Contractor shall have no duty or responsibility or liability all of which is expressly waived by you for losses, fines, penalties, testing, analysis, monitoring, cleaning, removal, disposal, abatement, decontamination, remediation, repair, replacement, relocation, loss of use of building, or building equipment and systems, or personal injury, sickness or disease associated with asbestos, mold, fungi, rust, corrosion or other bacteria or organisms. Any implied warranty of workmanlike construction, implied warranty of habitability or an implied warranty of fitness for a particular use hereby waived and disclaimed.

I authorize American Leak Detection to complete the above-described work and agree to the charges and terms as described. I further agree to pay reasonable charges for collection, including attorney's fees, court fees, and collection costs, in the event of my default. Homeowners are responsible for all charges not covered by Insurance company. Interest will be charged at a rate of 1.5% per month on accounts over 30 days. We accept all major credit cards. Please write invoice number on check.

I UNDERSTAND THE SCOPE OF WORK AND HEREBY AUTHORIZE AMERICAN LEAK DETECTION TO PERFORM THE ABOVE WORK. Any unforeseen conditions found to impact the scope of work will be written into a change order for authorization prior to proceeding.

Not included in the scope of work:

- Permits for inspection
- Landscape restoration
- Repairs to any existing irrigation appurtenances (valves, heads, etc)

State of California
Contractor Lic# 662920
Federal ID#33-0744492

1/31/2024

The work is satisfactory and the charges are agreed. I agree to pay a reasonable charge for collection, including attorneys's fee, in the event of my default, as well as penalty interest of 1.5% per month, 18% per annum. Homeowners are responsible for all charges not covered by insurance company.

"MECHANICS LIEN WARNING:

Anyone who helps improve your property, but who is not paid, may record what is called a mechanics lien on your property. A mechanics lien is a claim, like a mortgage or home equity loan, made against your property and recorded with the county recorder.

Even if you pay your contractor in full, unpaid subcontractors, suppliers, and laborers who helped to improve your property may record mechanics liens and sue you in court to foreclose the lien. If a court finds the lien is valid, you could be forced to pay twice or have a court officer sell your home to pay the lien. Liens can also affect your credit.

To preserve their right to record a lien, each subcontractor and material supplier must provide you with a document called a 'Preliminary Notice.' This notice is not a lien. The purpose of the notice is to let you know that the person who sends you the notice has the right to record a lien on your property if they are not paid.

BE CAREFUL. The Preliminary Notice can be sent up to 20 days after the subcontractor starts work or the supplier provides material. This can be a big problem if you pay your contractor before you have received the Preliminary Notices.

You will not get Preliminary Notices from your prime contractor or from laborers who work on your project. The law assumes that you already know they are improving your property.

PROTECT YOURSELF FROM LIENS. You can protect yourself from liens by getting a list from your contractor of all the subcontractors and material suppliers that work on your project. Find out from your contractor when these subcontractors started work and when these suppliers delivered goods or materials. Then wait 20 days, paying attention to the Preliminary Notices you receive.

PAY WITH JOINT CHECKS. One way to protect yourself is to pay with a joint check. When your contractor tells you it is time to pay for the work of a subcontractor or supplier who has provided you with a Preliminary Notice, write a joint check payable to both the contractor and the subcontractor or material supplier.

For other ways to prevent liens, visit CSLB's internet website at www.cslb.ca.gov or call CSLB at 800-321-CSLB (2752).

REMEMBER, IF YOU DO NOTHING, YOU RISK HAVING A LIEN PLACED ON YOUR HOME. This can mean that you may have to pay twice, or face the forced sale of your home to pay what you owe."

(5) The following notice shall be provided in at least 12-point typeface:

"Information about the Contractors State License Board (CSLB): CSLB is the state consumer protection agency that licenses and regulates construction contractors.

Contact CSLB for information about the licensed contractor you are considering, including information about disclosable complaints, disciplinary actions, and civil judgments that are reported to CSLB.

Use only licensed contractors. If you file a complaint against a licensed contractor within the legal deadline (usually four years), CSLB has authority to investigate the complaint. If you use an unlicensed contractor, CSLB may not be able to help you resolve your complaint. Your only remedy may be in civil court, and you may be liable for damages arising out of any injuries to the unlicensed contractor or the unlicensed

contractor's employees.

For more information:

Visit CSLB's internet website at www.cslb.ca.gov

Call CSLB at 800-321-CSLB (2752)

Write CSLB at P.O. Box 26000, Sacramento, CA 95826."

(6) (A) The notice set forth in subparagraph (B) and entitled "Three-Day Right to Cancel," or entitled "Five-Day Right to Cancel" for contracts with a senior citizen, shall be provided to the buyer:

(B) (i) "Three-Day Right to Cancel

You, the buyer, have the right to cancel this contract within three business days. You may cancel by emailing, mailing, faxing, or delivering a written notice to the contractor at the contractor's place of business by midnight of the third business day after you received a signed and dated copy of the contract that includes this notice. Include your name, your address, and the date you received the signed copy of the contract and this notice.

If you cancel, the contractor must return to you anything you paid within 10 days of receiving the notice of cancellation. For your part, you must make available to the contractor at your residence, in substantially as good condition as you received them, goods delivered to you under this contract or sale. Or, you may, if you wish, comply with the contractor's instructions on how to return the goods at the contractor's expense and risk. If you do make the goods available to the contractor and the contractor does not pick them up within 20 days of the date of your notice of cancellation, you may keep them without any further obligation. If you fail to make the goods available to the contractor, or if you agree to return the goods to the contractor and fail to do so, then you remain liable for performance of all obligations under the contract."

(ii) References to "three" and "third" in the notice set forth in clause (i) shall be changed to "five" and "fifth," respectively, for a buyer who is a senior citizen.

(C) The notice required by this paragraph shall comply with all of the following:

(i) The text of the notice is at least 12-point boldface type.

(ii) The notice is in immediate proximity to a space reserved for the owner's signature.

(iii) The owner acknowledges receipt of the notice by signing and dating the notice form in the signature space.

(iv) The notice is written in the same language, e.g., Spanish, as that principally used in any oral sales presentation.

(v) The notice may be attached to the contract if the contract includes, in at least 12-point boldface type, a checkbox with one of the following statements, as applicable:

(I) For a contract with a senior citizen: "The law requires that the contractor give you a notice explaining your right to cancel. Initial the checkbox if the contractor has given you a 'Notice of the Five-Day Right to Cancel.'"

(II) For all other contracts: "The law requires that the contractor give you a notice explaining your right to cancel. Initial the checkbox if the contractor has given you a 'Notice of the Three-Day Right to Cancel.'"

1/31/2024



Front of the house

Pressed test passed

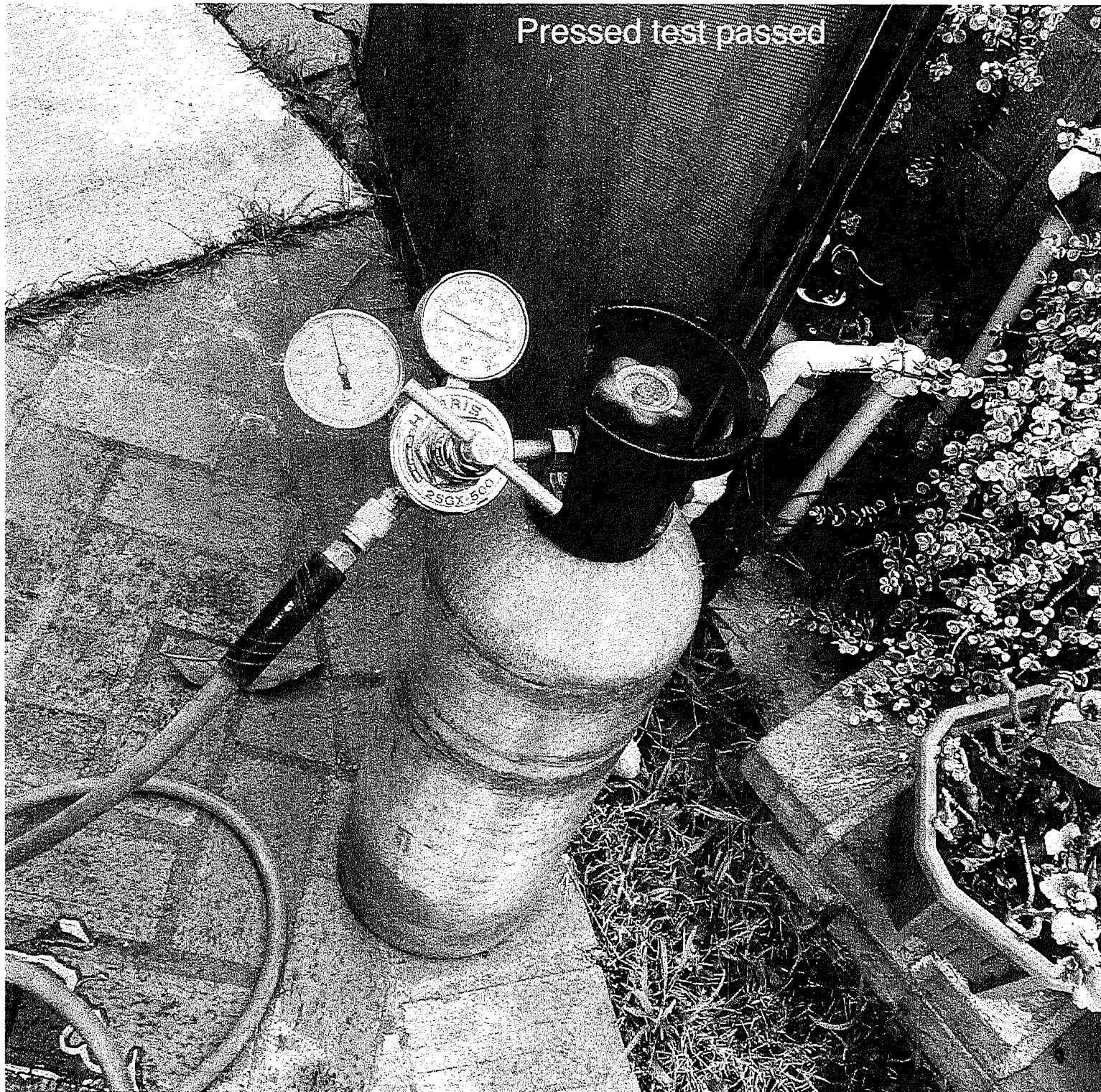





Hose bib



Joseph's Plumbing & Rooter

State Licence # 855251



5428 W. Ballast Ave., * Santa Ana, CA 92704
(714) 425-6890

Invoice:

Date: Jan - 29 - 24
 Time In: 2:50 Out: _____
 Serviceman: Tuan

Cleaned/ Fixed/ Replaced/ Installed

- Sewer Line
- Bath tub
- Shower
- Bath Sink
- Toilet
- Faucets
- Laundry
- Garbage Disposal
- Floor Sink
- Floor Drain
- Area Drain
- Clean Out
- Vent
- Water line
- Water Heater
- Urinal
- Gate/Ball Valve
- Copper Repiping
- Hydro-Jetting
- Water Softener
- Bathroom Remodeling
- Other

Name: Mrs. Joan W. Young
 Address: 13749 Palmdale Ave
 City: Garden Grove CA 92643
 Phone: 714-400-7801

Description of Work

Completed leak detection and pump
CO2 tank. Both lines hot and cold
the pipe is good (no leaks)
the pipe is on the attic and
about 100 ft.

	Amount
<input type="checkbox"/> Drain Cleaning	_____
<input type="checkbox"/> Plumbing Labor	_____
<input type="checkbox"/> Parts	_____
<input type="checkbox"/> Video Inspection	_____
<input type="checkbox"/> Line/Leak Location	<u>2.95</u>
<input type="checkbox"/> Slab Leak	_____
<input type="checkbox"/> Other	_____
Tax	_____
Total	<u>2.95</u>
Credit Card <input type="checkbox"/> Cash <input type="checkbox"/> Charge <input type="checkbox"/>	Ck# _____

THANK YOU...WE APPRECIATE YOUR BUSINESS

TO OUR CUSTOMER: This invoice authorizes the above service. Our purpose is to serve. All questions welcome. Thirty (30) days warranty unless otherwise specified. No warranty without proper access or on corroded, damaged, disjointed and improperly installed pipe. An express mechanic's lien to secure the amount of charge is hereby acknowledged (Section 7018. CA Bus. and Prof. Code).

Customer Authorization _____



CITY HALL
11222 Acacia Parkway
Garden Grove, CA 92840

7:30 AM - 5:30 PM Monday - Thursday
7:30 AM - 5:00 PM Alternating Fridays

GARDEN GROVE

- To pay online visit <https://ggcity.org/water>
- To pay by phone, please call 1-888-867-2992
- Make checks payable to City of Garden Grove

GG0122A 366 1 AV 0.507
7000000383 00.0003.0293 366/1



NGUYEN, NGAN
13349 RAMONA DR
GARDEN GROVE CA 92843-2642

Service Period	Number of Days
11/13/2023 to 01/17/2024	65

Previous Read	Current Read	Units Used
2550	3517	967

Approximately 723,316 gallons used for this billing cycle. Each billing unit equals 100 cubic feet or 748 gallons of water.

Consumption in Billing Units

Last year Current year



From least current billing to most current

AutoPay + Paperless Billing
On time. Every time. <https://ggcity.org/h2o/guest>

MOVING? Contact the City service to close
VACANT BUILDING? Your water account. (714) 741-5078

NEW WATER RATES EFFECTIVE JANUARY 11, 2024

For more info, visit
<http://www.ggcity.org/finance/water-rates>

Customer: NGUYEN, NGAN
Account Number: 300255007
Service Address: 13349 RAMONA DR
Service Type: Single family home
Meter Size: 5/8"x3/4"
Bill Date: 01/22/2024

Previous Balance:		0.00
Water Tier 1	33 units @ \$3.40	112.20
Water Tier 2	934 units @ \$5.29	4940.86
Water Service Charge		35.10
Water Capital Improvement		7.45
Sewer Service Charge		26.68
Current Charges:		\$5,122.29
Amount Now Due:		\$5,122.29
Due by 02/26/2024		

If paid later than 03/04/2024 pay \$5,142.99

Low-income Household Water Assistance Program
(714) 839-6199 • capoc.org/water • LHWAP@capoc.org

Water Emergency? Call (714) 741-5395.
Customers and plumbers are NOT to operate the water meter shut off valve. Damage to the meter shut off valve will be billed.

PLEASE RETURN THIS PORTION WITH WATER PAYMENT

ACCOUNT NUMBER: 300255007
AMOUNT DUE: \$5,122.29
DUPLICATE DATE: 02/26/2024

Check here for address correction. Fill out form on back.



CITY OF GARDEN GROVE
PO BOX 3070
GARDEN GROVE, CA 92842-3070

Customer Service: (714) 741-5078 - <https://ggcity.org>
Pay online at: <https://ggcity.org/water>
To pay by phone, please call 1-888-867-2992.

Service Address: 13349 RAMONA DR
Billing Date: 01/22/2024
Date Approved/Read: 03/15/2024

ATTACHMENT

2

ATTACHMENT

3

Route History

Service Id or Address

13349 Ramona Drive

Action type



Request from:

mm/dd/yyyy

Range

Search:

Service	Type	Requested	Req By	Remark		Notes			
30025500	Prelim Read	2024-01-22	system	Flow indicator moving/flashing	Customer talked to Tina and had a toilet leak	2024-01-22 13:04:35 -0800	davidm	3521	Y
30025500	Prelim Read	2022-07-07	system	Meter not stopped		2022-07-07 12:20:33 -0700	davidm	2370	Y

Showing 1 to 2 of 2 entries

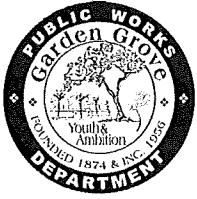

GARDEN GROVE PUBLIC WORKS DEPARTMENT SERVICE REQUEST #564639

Service Request: 564639

Department:

Status: CLOSED

Priority: NORMAL

Created at: January 31, 2024 09:01AM

Request: 3cf Meter test

Location: 13349 RAMONA DR,

Public Property: YES

Square Feet:

New Meter: #96219881 (Read: 0)

Old Meter: #73549200 (Read: 3528)

Service line material (City):

Service line material (Customer):

Constuction:

Requester: David Ma'ae

Home Phone:

Work Phone:

Other Phone:

Created by: davidm

Eng. Permit:

Police Num.:

Fire Num.:

Chlorine Res Free:

Chlorine Res Total:

Task #1

Status: CLOSED on January 31, 2024 09:57AM by David Ma'ae

Description: 3cf Meter test. Steve Moya and I was going to start meter test when LFI started moving. Customer said he had nothing on but LFI was moving in a stop and go motion. Unable to do meter test when LFI is moving. Customer said he going to dispute bill.

Category: W99 Water Meter Test (AUTO-NOTIFY) **Assigned to:** David Ma'ae

Division: WATER SERVICES

Requester contacted:

Completed by: David Ma'ae

ECD:

Task #2

Status: CLOSED on February 07, 2024 01:00PM by Andrew Ornelas

Description: Les requested a change out meter for 3rd party test.

I will give Jon Ruiz meter for testing and Andrew will program new meter.

Comments: Programmed for amr.

Category: W85 METER PROGRAMMING

Assigned to: Andrew Ornelas

Division: WATER SERVICES

Requester contacted:

Completed by: Andrew Ornelas

ECD:

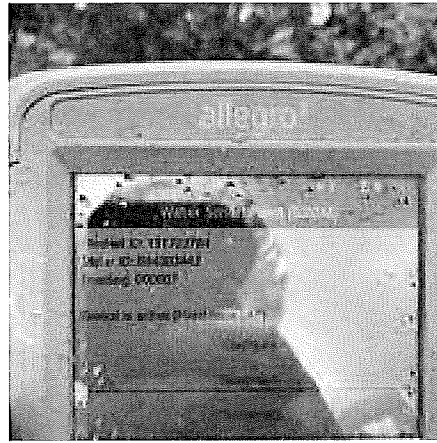
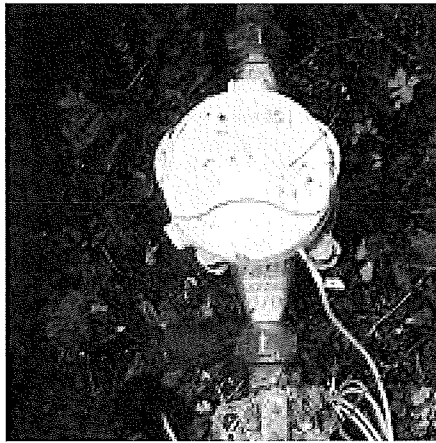
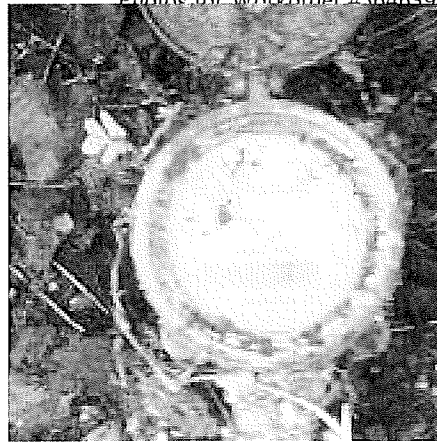
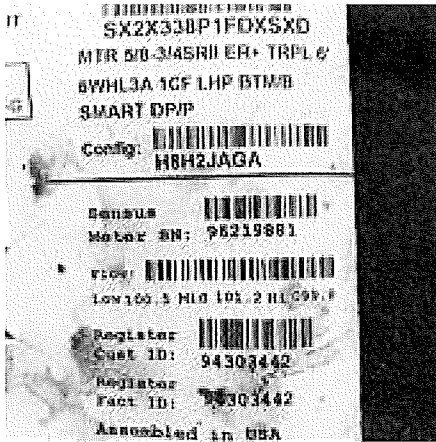

ATTACHMENT

4

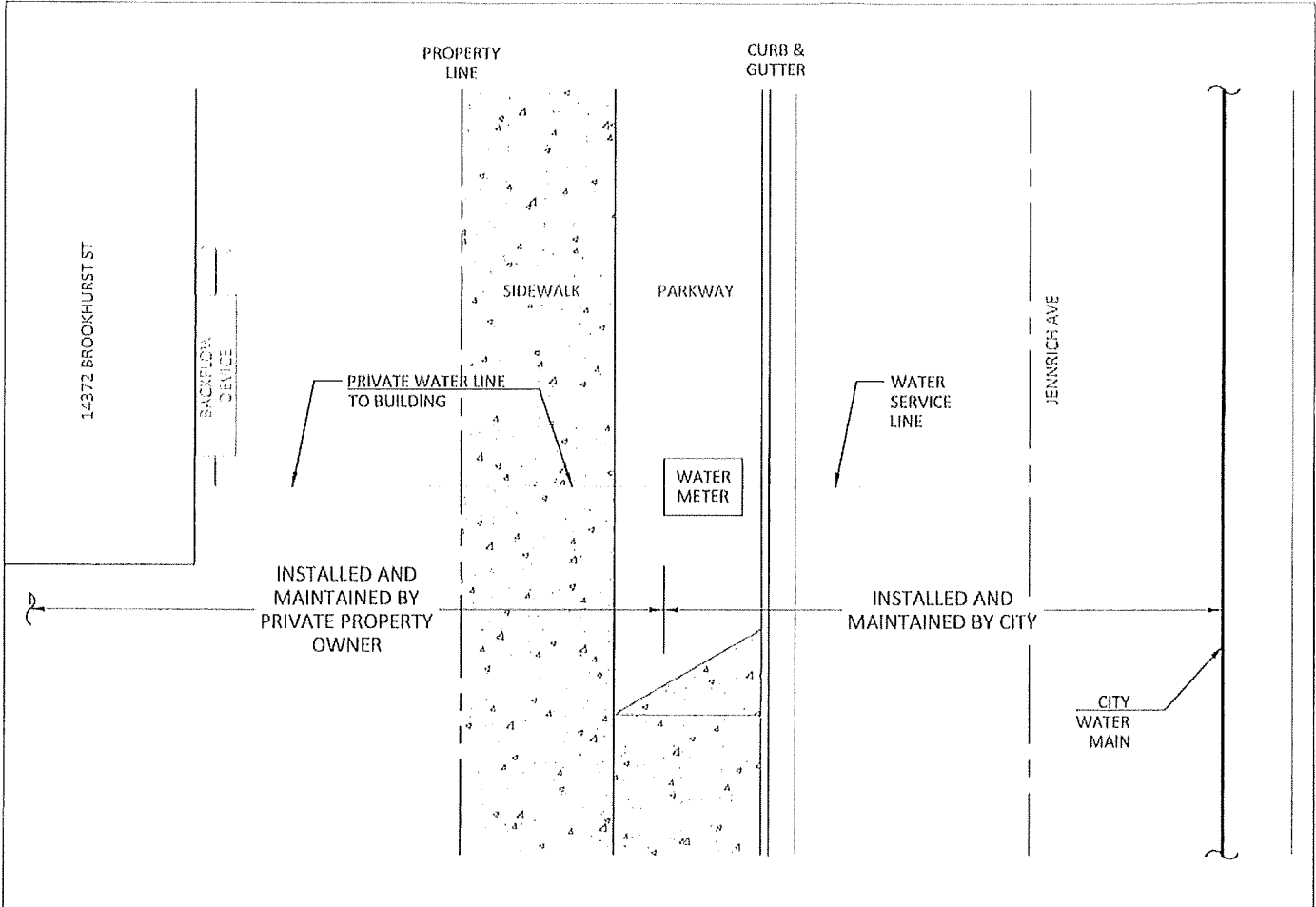
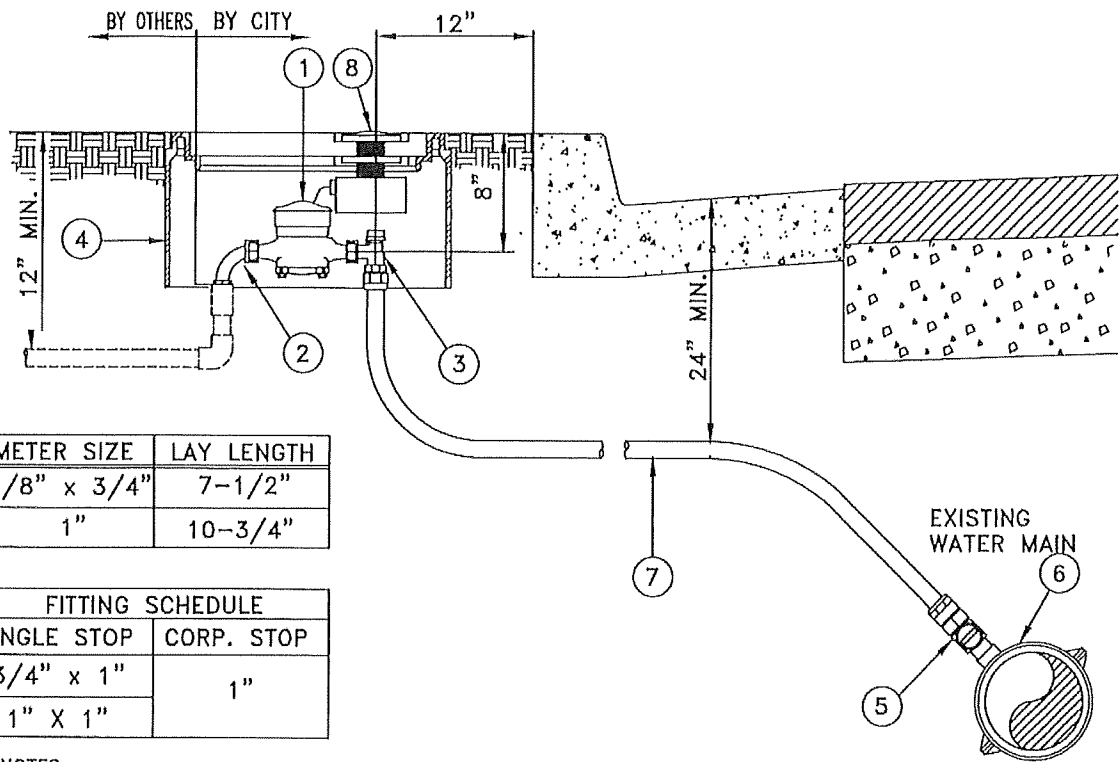

EXHIBIT 1
OWNER / CITY MAINTENANCE RESPONSIBILITY
FOR WATER SERVICE LINE



METER SIZE	LAY LENGTH
5/8" x 3/4"	7-1/2"
1"	10-3/4"

FITTING SCHEDULE	
ANGLE STOP	CORP. STOP
3/4" x 1"	1"
1" X 1"	

NOTES

1. ALL CITY SERVICES TO BE TYPE "K" SOFT COPPER.
2. TUBING TO BE ONE CONTINUOUS PIECE, NO SPLICES OR HEATING PERMITTED UNLESS APPROVED BY WATER SERVICES.
3. TAPS SHALL BE MADE AT LEAST 12" FROM ANY OTHER TAP OR COUPLING. STAGGER ANGLE OF TAPS MADE NEXT TO EACH OTHER 15°.
4. METER, METER BOX, ANGLE METER VALVE AND TAILPIECE, BY CITY AT CONTRACTOR'S EXPENSE, UNLESS OTHERWISE APPROVED.

MATERIAL LIST

ITEM NO.	QUAN.	DESCRIPTION	MFR.
①	1	5/8" OR 1" SMART METER	SENSUS, SRII
②	1	3/4" OR 1" ANGLE METER COUPLING	
③	1	3/4" x 1" OR 1" x 1" BALL ANGLE METER VALVE, COMPRESSION TYPE OR APPROVED EQUAL	WUELLER, JONES OR FORD
④	1	POLYMER METER BOX (DFW486WBC-12-1 OR APPROVED EQUAL)	DFW PLASTICS OR APPROVED EQUAL
⑤	1	1" CORPORATION STOP (COMPRESSION TYPE), BALL TYPE, C.C. THREAD	WUELLER, JONES OR FORD
⑥	1	SERVICE SADDLE DOUBLE STRAP (FORD 202BSD OR APPROVED EQUAL)	WUELLER, JONES OR FORD
⑦	AS NEEDED	1# SOFT COPPER TUBING, TYPE "K"	
⑧	1	FLEXNET SMARTPOINT 520W MODULE (OR APPROVED EQUAL)	SENSUS



1" COPPER WATER SERVICE INSTALLATION FOR 5/8" & 1" METERS

Approved: *[Signature]* Date: 05-18-21
 City Engineer R.C.E. 52125 Exp. 12-31-22

REVISIONS	BY	DATE

STD. PLAN NUMBER
B-721
 SHEET 1 OF 1

ATTACHMENT

5

RESOLUTION NO. 003-2024

A RESOLUTION OF THE ADMINISTRATIVE BOARD OF APPEALS OF THE CITY OF GARDEN GROVE, CALIFORNIA, DENYING THE APPEAL OF NGAN NGUYEN OF THE GARDEN GROVE PUBLIC WORKS DIRECTOR'S DENIAL OF HIS REQUEST TO ADJUST WATER BILLS FOR ONE BILLING PERIOD FROM NOVEMBER 13, 2023 TO JANUARY 17, 2024.

WHEREAS, Ngan Nguyen ("Appellant") requested an adjustment to his water bill for one billing period from November 13, 2023 to January 17, 2024; and

WHEREAS, the Public Works Director denied Appellant's request and Appellant appealed the Director's decision on February 1, 2024; and

WHEREAS, on March 27, 2024, a hearing before the Administrative Board of Appeals of the City of Garden Grove was held at which the Administrative Board of Appeals considered testimony and evidence related to the Appellant's appeal of the Director's decision and continued the hearing to receive additional information requested by the Board; and

WHEREAS, Appellant and all other persons with an interest in the subject matter of the appeal were afforded an opportunity to be heard and present evidence to the Administrative Board of Appeals of the City of Garden Grove at its March 27, 2024 hearing.

NOW, THEREFORE, THE ADMINISTRATIVE BOARD OF APPEALS OF THE CITY OF GARDEN GROVE, CALIFORNIA, DOES RESOLVE, DECLARE, DETERMINE, AND ORDER AS FOLLOWS:

SECTION 1. The Administrative Board of Appeals of the City of Garden Grove hereby makes the following findings of fact:

1. The City was formally informed of a high water bill from Appellant on May 26, 2023 regarding a higher than normal water use after receiving a bill for the period of May 23, 2023 to May 18, 2023, in the amount of \$928.05 for the use of 191 units (approximately 3.41 units per day).
2. On January 22, 2024, City was conducting routine meter reading and noticed the low flow indicator was moving which indicates a possible leak at Appellant's property. City staff verbally notified the resident of potential leak in English and translated in Vietnamese over the phone.
3. City staff re-read the meter and confirmed low flow indicator was moving. City staff spoke with occupant and was informed two toilets had been leaking last month and had recently been fixed.
4. On January 29, 2024, Appellant made initial contact with the City to inform the City of a higher than normal water use after receiving a bill for the period of November 13, 2023 to January 17, 2024, in the amount of \$5,122.29 for the use of 967 units (approximately 14.88 units per day).

5. Appellant provided two plumber’s invoice inspection reports showing no leak. One inspection report was received from Joseph’s Plumbing & Rooter, dated January 29, 2024. The second inspection report was received on January 31, 2024, invoice #138676591.
6. City staff scheduled an in-ground meter test to be performed on January 31, 2024 at 9:57 a.m. On that day, City staff was unable to perform the test due to the low flow indicator moving. City staff verbally notified the resident of a potential leak.
7. On February 7, 2024, City staff removed the old water meter and replaced it permanently with a new water meter.
8. The old water meter was tested by Westerly on February 8, 2024. The test results passed, according to the American Water Works Association standards.
9. The property’s occupant communicated to the City “good faith” efforts on their part in regard to informing the City of two leaking toilets that were repaired.
10. Appellant communicated to the City “good faith” efforts on their part in regard to performing independent investigations and repairs. However, the plumber reports only confirm Appellant’s responsibility for the leaks due to the inspections and repairs taking place after the billing period from November 13, 2023 to January 17, 2024.
11. The Public Works Director correctly denied the Appellant’s request to adjust and reduce its water bills.

SECTION 2. Based on the findings of fact referenced herein and after consideration of all relevant testimony and evidence submitted at the March 27, 2024 meeting of the Administrative Board of Appeals of the City of Garden Grove, the decision of the Public Works Director denying Appellant’s request for billing adjustments is hereby affirmed, and the appeal filed by Ngan Nguyen on February 1, 2024, is hereby denied.

SECTION 3. The Building Official is directed to provide notice of the decision of the Administrative Board of Appeals and of this Resolution to Appellant, Ngan Nguyen within seven (7) days of the date this Resolution is adopted.

SECTION 4. This Resolution shall become final effective immediately.

Adopted this 27th day of March, 2024.

ATTEST:

CHAIR

SECRETARY

STATE OF CALIFORNIA)
COUNTY OF ORANGE) SS:

CITY OF GARDEN GROVE)

I, JUDITH MOORE, Secretary of the City of Garden Grove Administrative Board of Appeals, do hereby certify that the foregoing Resolution was duly adopted by the Administrative Board of Appeals of the City of Garden Grove, California, at a Special Meeting held on the 27th day of March, 2024, by the following vote:

AYES: BOARD MEMBERS:
NOES: BOARD MEMBERS:
ABSTAIN BOARD MEMBERS:
ABSENT: BOARD MEMBERS:

SECRETARY

PLEASE NOTE: Any request for court review of this decision must be filed within 90 days of the date this decision was final (See Code of Civil Procedure Section 1094.6).