

City of Garden Grove
WEEKLY CITY MANAGER'S MEMO
September 20, 2018

TO: Honorable Mayor and City Council FROM: Scott C. Stiles, City Manager
Members

I. DEPARTMENT ITEMS

A. ENVISION WILLOWICK!

Information on upcoming workshops to help envision the future of the Willowick Golf Course site is included.

B. PUBLIC RECORDS REQUESTS LOG

The City Clerk provides a copy of the Public Records request for August 2018 for your perusal.

II. ITEMS FROM OTHER GOVERNMENTAL AGENCIES, OUTSIDE AGENCIES, BUSINESSES AND INDIVIDUALS

- A.** The Municipal Water District of Orange County (MWDOC) provides the Monthly Water Supply Report for September 2018.

• **OTHER ITEMS**

– **SOCIAL MEDIA HIGHLIGHTS AND NEWSPAPER ARTICLES**

Copies of the week's social media posts and local newspaper articles are attached for your information.

– **MISCELLANEOUS ITEMS**

Items of interest are included.

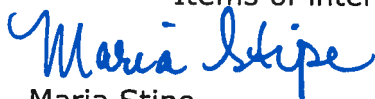

Maria Stipe
Deputy City Manager

Envision Willowick!

Visioning is a process where a community imagines and identifies the future that it wants.

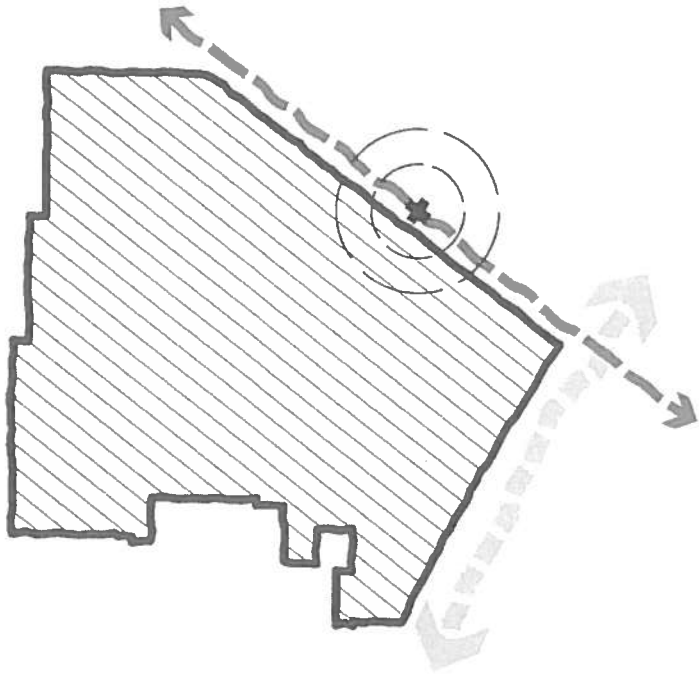

About the Vision Plan

The Cities of Garden Grove and Santa Ana invite you to help develop a Vision Plan for the redevelopment of the Willowick Golf Course site. This process will explore conceptual land use options that are formed by community and stakeholder collaboration and input. The Vision Plan will be used to guide the solicitation of development plans for Willowick.

This visioning process will explore how Willowick can best serve and enrich the community. The Vision Plan will be a compilation of community-driven needs, goals, ideas, and feedback. The more perspectives shared - the better! Working together with the community is important to us in answering key questions such as:

- *What activities and programs are needed?*
- *How can it celebrate Santa Ana and Garden Grove's rich heritage and environment while keeping pace with changing conditions and trends?*

Help **envision** the future of the Willowick Golf Course site!

Listen

Workshop #1

August 30

Goodwill Industries

410 N. Fairview St.
Santa Ana, CA 92703

6-8 pm

Explore ideas, needs and goals of the community.

Create

Workshop #2

September 27

Spurgeon Intermediate School

2701 W. 5th St.
Santa Ana, CA 92703

6-8 pm

Explore economic and market forces, then brainstorm and map your ideas for the future of Willowick.

Workshop #3

October 2

Buena Clinton Youth and Family Center

12661 Sunswept Ave.
Garden Grove, CA 92843

6-8 pm

Evaluate

Workshop #4

October 25

Spurgeon Intermediate School

2701 W. 5th St.
Santa Ana, CA 92703

6-8 pm

Provide feedback on alternative concepts developed on input from the previous workshops.

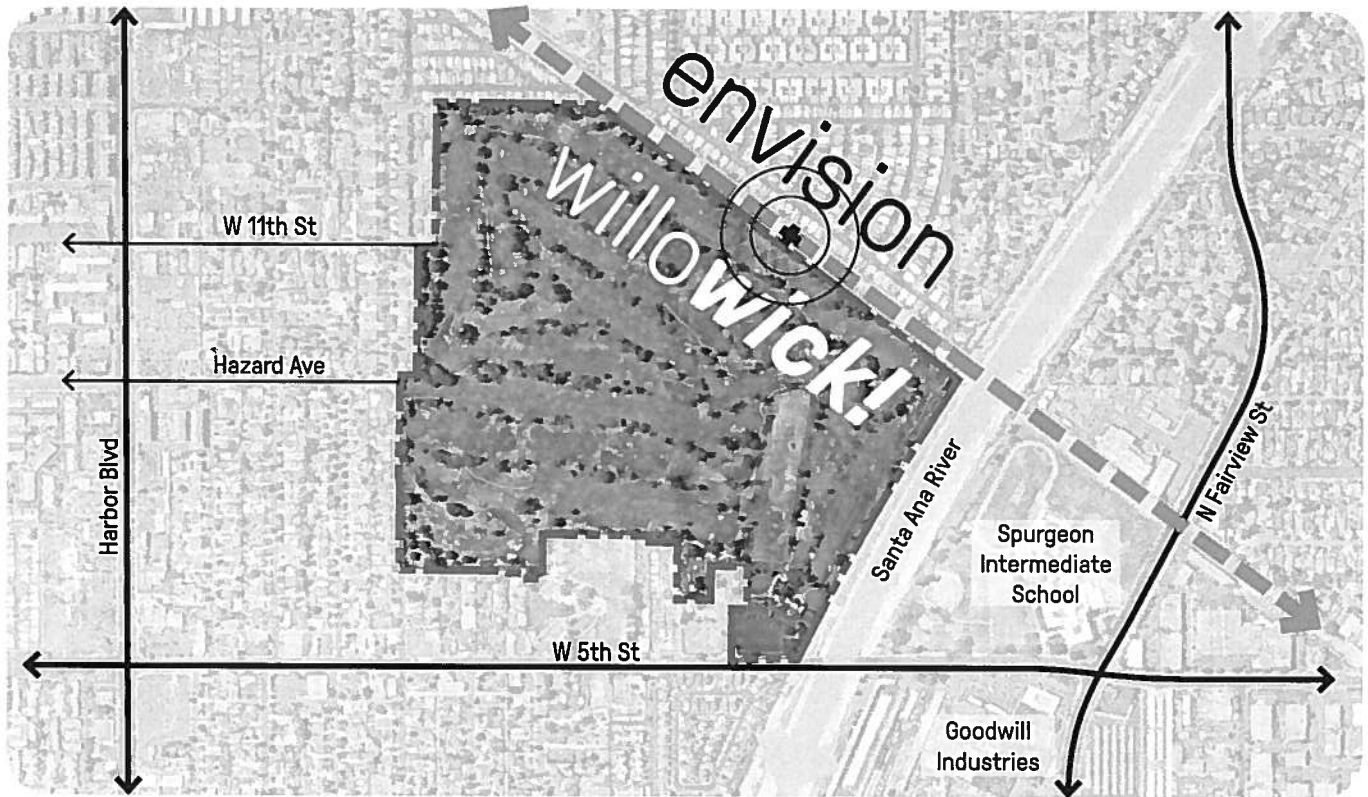

The Willowick Golf Course site, located in the City of Santa Ana, is situated on 5th Street, adjacent to the Santa Ana River, at 3017 W 5th Street. Owned by the City of Garden Grove, the property is currently an 18-hole golf course. The site is adjacent to the Santa Ana River on the east, the Pacific Electric (PE) Right-of-Way on the north, and abuts Garden Grove's Buena Clinton neighborhood. To the east across the Santa Ana River, is Spurgeon Intermediate School and Spurgeon Park. To the west of the site is the Santa Anita neighborhood of Santa Ana. Directly to the south, is Cesar Chavez Campesino Park.

Get Involved!

Your involvement and input builds the foundation of the Vision Plan!

You can help us by sharing ideas and providing feedback that will shape design concepts and alternatives. Join us in creating the vision by participating in any or all of the workshops.



Need More Info?

Visit the website:



www.ggcity.org/econdev/envision-willowick

Contact your Community Development Department:

Garden Grove



Mary Medrano
Associate Planner
marym@ggcity.org
714-741-5315



Lisa Kim
Community and Economic Development Director
lisak@ggcity.org
714-741-5121

Santa Ana



Vince Fregoso
Principal Planner
vfregoso@santa-ana.org
714-667-2713

월로윅의 미래를 그리다!

주민이 원하는 미래를 상상하고 확인함으로써 비전을 수립합니다.

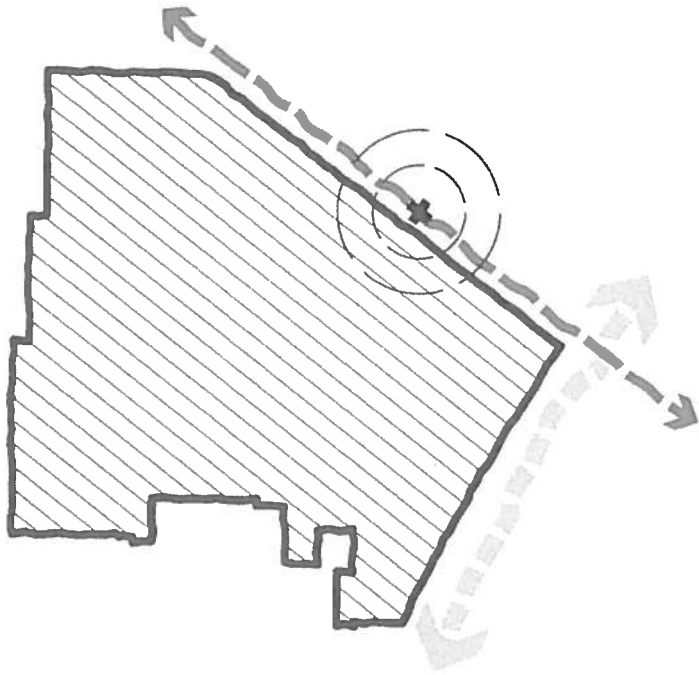

비전 플랜 소개

가든그로브와 샌타애나 시는 월로윅 골프장 재개발을 위한 비전 계획 구상에 도움을 얻고자 여러분을 초대합니다. 주민과 이해관계자의 협업과 의견으로 도출된 개념적 토지 사용 옵션을 검토할 예정입니다. 비전 플랜은 월로윅에 대한 개발 계획의 입찰공고에 사용될 것입니다.

비전 수립 과정에서는 월로윅이 주민에게 최선의 봉사과 풍요를 제공할 수 있는 방법에 대해 검토합니다. 비전 플랜은 주민이 주도하는 요구, 목표, 아이디어 및 피드백을 취합하여 구상됩니다. 더 많은 의견이 공유될수록 결과는 더 좋아집니다! 주민과의 협동은 다음과 같은 핵심 질문에 대한 해답을 구하는 데 있어서 중요한 역할을 합니다.

- 어떤 활동과 프로그램이 필요한가?
- 변화하는 상황과 추세에 보조를 맞추면서도 샌타애나와 가든그로브의 풍부한 유산과 환경을 기념할 수 있을 것인가?

월로윅 골프장 미래를 위한 비전 제시

듣기

워크샵 #1

8월 30일

Goodwill Industries
410 N. Fairview St.
Santa Ana, CA 92703

오후 6시~8시

주민의 아이디어와 요구, 목표를 탐구합니다.

구상하기

워크샵 #2

9월 27일

Spurgeon
Intermediate School
2701 W. 5th St.
Santa Ana, CA 92703

오후 6시~8시

경제적 및 시장 영향력을 탐구하고, 월로윅의 미래에 대한 여러분의 의견을 바탕으로 계획을 구상합니다.

워크샵 #3

10월 2일

Buena Clinton Youth
and Family Center
12661 Sunswpt Ave.
Garden Grove, CA 92843

오후 6시~8시

평가하기

워크샵 #4

10월 25일

Spurgeon
Intermediate School
2701 W. 5th St.
Santa Ana, CA 92703

오후 6시~8시

이전 워크샵에서 제시된 정보에 따라 발전된 대안적 개념에 대해 피드백을 제공합니다.



윌로윅 골프장은 샌타애나 시의 5번가에 위치하고 있으며, 샌타애나 강 근처의 5번가 3017 W에 자리잡고 있습니다.

가든그로브 시의 소유로서, 이곳에는 18홀 골프장이 있습니다. 골프장은 동쪽으로 샌타애나 강, 북쪽으로 퍼시픽 일렉트릭 (PE) 통행로와 인접해 있으며, 가든그로브의 부에나클린턴 마을과 맞닿아 있습니다.

샌타애나 강을 건너 동쪽으로 스퍼전 중학교와 스퍼전 공원이 있습니다. 골프장의 서쪽으로 샌타애나의 산타 아니타 마을이 있습니다. 정남쪽으로는 세자르 차베스 캄페시노 공원이 있습니다.

참여하세요!

여러분의 참여와 의견이 비전 플랜의 토대가 됩니다!

아이디어를 공유하고 피드백을 제공함으로써 디자인 개념과 대안을 만들어 나가는 데 기여할 수 있습니다. 워크샵에 참석해 비전을 만들어 나가는 데 동참해주시기 바랍니다.



추가 정보가 필요하십니까?

웹사이트 방문:



www.ggcity.org/econdev/envision-willowick

주민 개발부 연락처:

가든그로브



Mary Medrano
Associate Planner
marym@ggcity.org
714-741-5315



Lisa Kim
Community and Economic Development Director
lisak@ggcity.org
714-741-5121

샌타애나



Vince Fregoso
Principal Planner
vfregoso@santa-ana.org
714-667-2713

¡Una Visión Para Willowick!

Creando una visión es un proceso donde una comunidad imagina e identifica un futuro deseado.

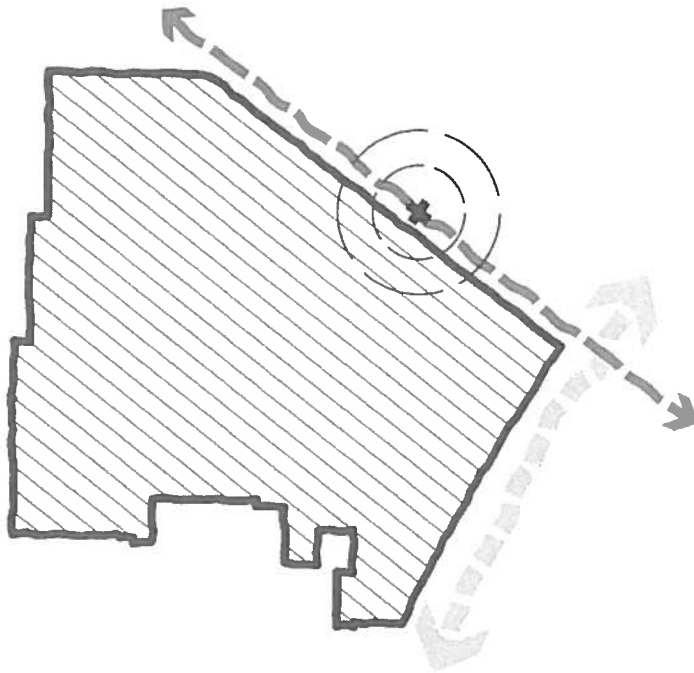

Sobre el Plan De Visión

Las Ciudades de Garden Grove y Santa Ana buscan su ayuda para desarrollar un Plan de Visión para el re-desarrollo del sitio del campo de golf Willowick. Este proceso explorara opciones conceptuales para el uso del sitio formados por la comunidad y la colaboración de otros interesados. El Plan de Visión se usara para guiar la solicitud del plan de desarrollo para Willowick.

El proceso de visión explorara como Willowick puede mejor servir y enriquecer la comunidad. El plan será una compilación de las necesidades, objetivos, ideas, y opiniones dirigidos por la comunidad. ¡Entre más perspectivas compartidas—mejor será! Trabajando junto con la comunidad es importante para nosotros para responder a preguntas claves como:

- *¿Que actividades y programas son necesarios?*
- *¿Como celebran el rico patrimonio y el ambiente de Santa Ana y Garden Grove mientras estando al par con cambios y las tendencias del último momento?*

¡Ayúdenos formar una **vision** para el futuro del sitio Willowick!

Escuchar

Taller #1

30 de Agosto

Goodwill Industries

410 N. Fairview St.
Santa Ana, CA 92703

6-8 pm

Explore ideas, necesidades y objetivos de la comunidad.

Crear

Taller #2

27 de Septiembre

Escuela Intermedia Spurgeon

2701 W. 5th St.
Santa Ana, CA 92703

6-8 pm

Explore fuerzas económicas y del mercado, luego una sesión de ideas usando mapas.

Taller #3

2 de Octubre

Centro Para Jovenes y Familias de Buena Clinton

12661 Sunswept Ave.
Garden Grove, CA 92843

6-8 pm

Evaluar

Taller #4

25 de Octubre

Escuela Intermedia Spurgeon

2701 W. 5th St.
Santa Ana, CA 92703

6-8 pm

Opiniones sobre conceptos alternativos desarrollados por ideas de talleres anteriores.

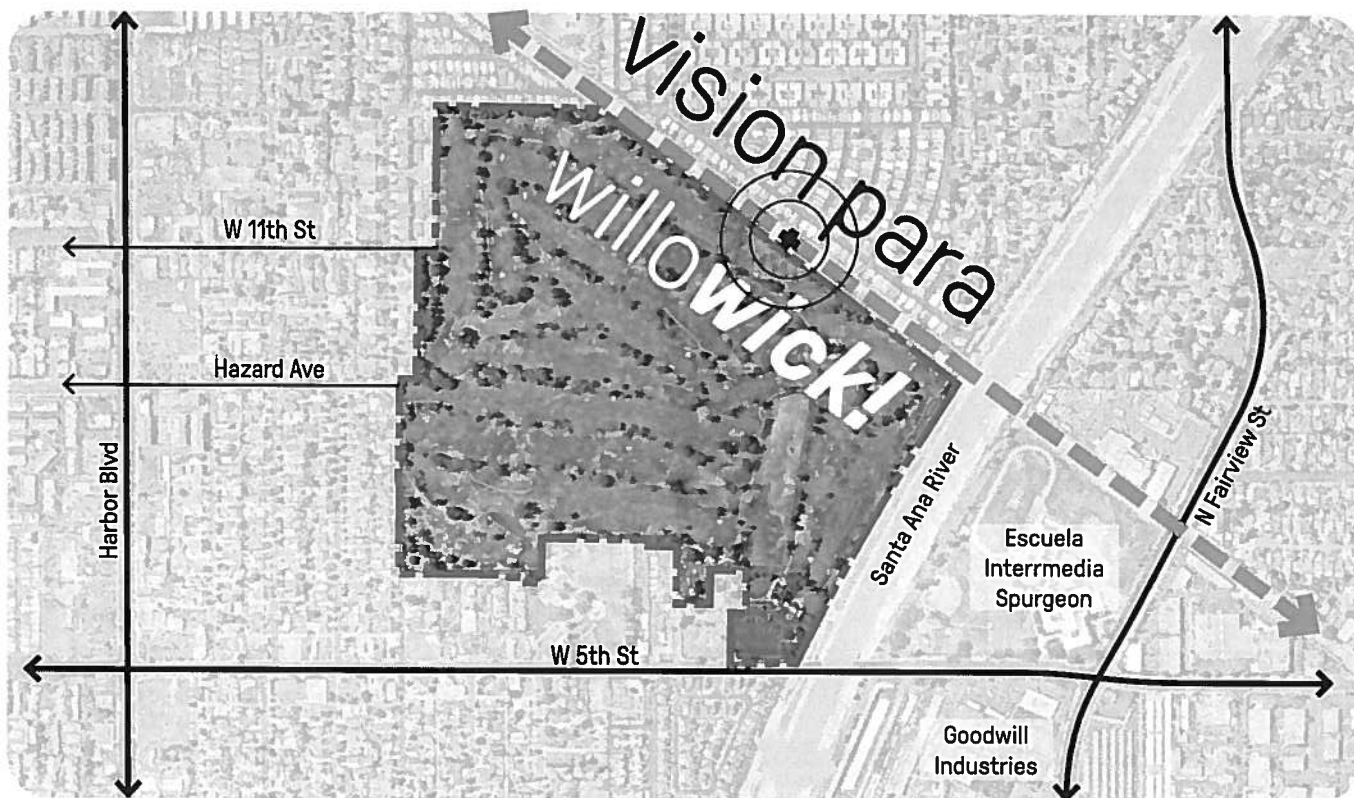

El sitio de campo de golf Willowick está ubicado en la ciudad de Santa Ana, en la 5a Calle, adyacente al río Santa Ana, en 3017 W 5th Street. Perteneciendo a la Ciudad de Garden Grove, la propiedad es actualmente un campo de golf de 18 hoyos. El sitio está junto al río Santa Ana en el este, el paso del Pacific Electric (PE) en el norte, y colinda con el vecindario Buena Clinton en Garden Grove. Hacia el este a través del río de Santa Ana, está la escuela intermedia Spurgeon y el parque Spurgeon. Al oeste del sitio está el vecindario Santa Anita en Santa Ana. Directamente al sur está el parque Campesino Cesar Chávez.

¡Participa!

Su participación e ideas construyen la base del plan de visión.

Ayúdenos compartiendo sus ideas y opiniones que darán forma a conceptos de diseño y alternativas. Acompáñenos en creando la visión participando en todos o cualquier de los talleres.



¿Necesita Mas Información?

Visite el sitio web:



www.ggcity.org/econdev/envision-willowick

Pongase en contacto con su Depto. de Desarrollo Comunitario:

Garden Grove



Mary Medrano
Associate Planner
marym@ggcity.org
714-741-5315



Lisa Kim
Community and Economic Development Director
lisak@ggcity.org
714-741-5121

Santa Ana



Vince Fregoso
Principal Planner
vfregoso@santa-ana.org
714-667-2713

Hình Dung Willowick!

Tầm nhìn là quá trình mà cộng đồng tưởng tượng và xác định tương lai muốn có.

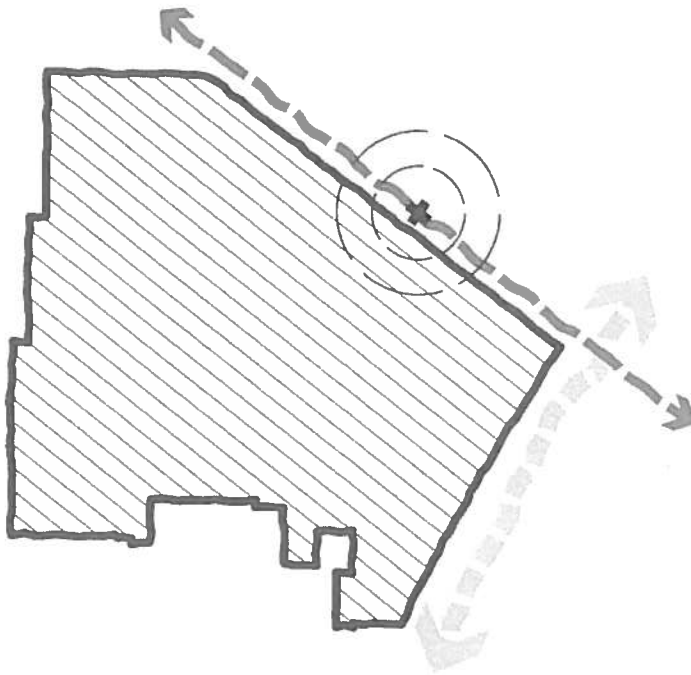

Giới thiệu về Kế Hoạch Tầm Nhìn

Thành Phố Garden Grove và Santa Ana cùng mời cộng đồng tham gia giúp phát triển một Kế Hoạch (Vision Plan) để tái phát triển khu vực sân golf Willowick. Quá trình bao gồm việc tham khảo các lựa chọn cách sử dụng khu đất được hình thành bởi cộng đồng và các bên liên quan. Kế hoạch sẽ được sử dụng để hướng dẫn việc phát triển cho khu Willowick.

Quá trình quan sát này sẽ khám phá cách Willowick có thể phục vụ và làm phong phú cho cộng đồng tốt nhất. Kế Hoạch Tầm Nhìn (Vision Plan) sẽ là một kế hoạch của cộng đồng- nhằm thúc đẩy nhu cầu, mục tiêu, ý tưởng và ý kiến phản hồi. Càng có nhiều quan điểm được chia sẻ thì càng tốt! Làm việc cùng cộng đồng là điều quan trọng đối với chúng tôi khi trả lời các câu hỏi chính như:

- Những hoạt động và chương trình nào là cần thiết?
- Làm thế nào để có thể tôn vinh di sản và môi trường giàu có của Thành phố Santa Ana và Garden Grove trong khi vẫn theo kịp với những thay đổi về điều kiện và xu hướng?

Hãy Hình Dung Tương Lai Của Sân Golf Willowick!

Lắng nghe

Hội thảo #1

30/8/2018

Goodwill Industries

410 N. Fairview St.
Santa Ana, CA 92703

6:00 - 8:00 p.m.

Khám phá ý tưởng, nhu cầu và mục tiêu của cộng đồng.

Sáng Tạo

Hội thảo #2

27/9/2018

**Spurgeon
Intermediate School**

2701 W. 5th St.
Santa Ana, CA 92703

6:00 - 8:00 p.m.

Khám phá tiềm năng kinh tế và thị trường, sau đó lên ý tưởng và phát thảo ý tưởng của bạn cho tương lai của Willowick.

Hội thảo #3

2/10/2018

**Buena Clinton Youth
and Family Center**

12661 Sunswept Ave.
Garden Grove, CA 92843

6:00 - 8:00 p.m.

Đánh Giá

Hội thảo #4

25/10/2018

**Spurgeon
Intermediate School**

2701 W. 5th St.
Santa Ana, CA 92703

6:00 - 8:00 p.m.

Thu nhận ý kiến phản hồi về các khái niệm được phát triển dựa trên thông tin từ các buổi hội thảo trước.

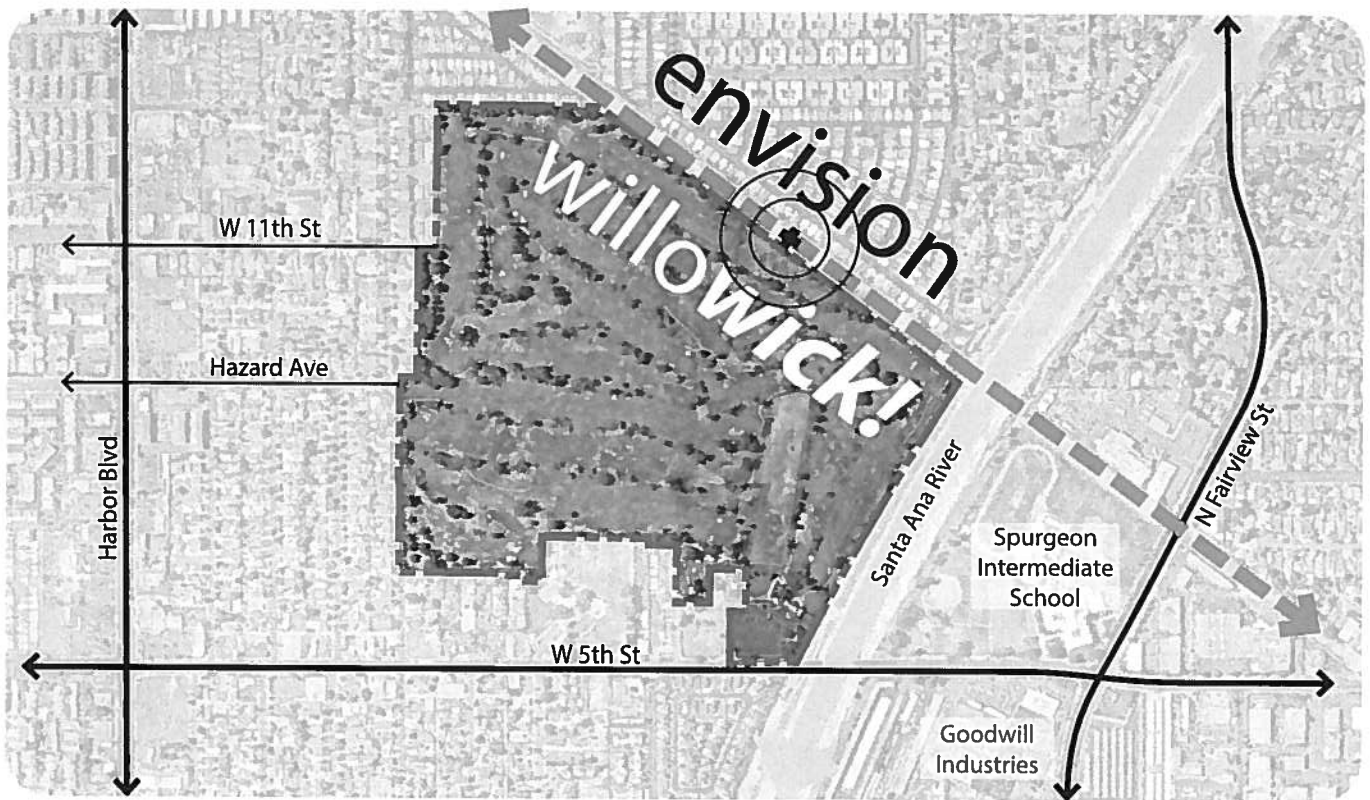

Sân Golf Willowick tọa lạc ở Thành phố Santa Ana, nằm trên Đường 5th Street, ngay cạnh Sông Santa Ana, tại địa chỉ 3017 W. 5th Street. Nơi này hiện đang là sân golf 18 lỗ thuộc sở hữu của Thành phố Garden Grove. Khu vực này nằm tiếp giáp với sông Santa Ana ở phía đông, phía bắc là Pacific Electric (PE) Right-of-Way, và ở tiếp giáp trung tâm Buena Clinton của Garden Grove. Về phía đông bên kia sông Santa Ana là trường tiểu học Spurgeon và công viên Spurgeon. Bên phía tây của khu vực là khu phố Santa Anita của Santa Ana. Trực tiếp về phía nam là Công viên Cesar Chavez Campesino.

Cùng Tham Gia!

SỰ THAM GIA VÀ GÓP Ý CỦA BẠN XÂY DỰNG NỀN TẢNG CHO KẾ HOẠCH!

Bạn có thể giúp chúng tôi bằng cách chia sẻ ý tưởng và đóng góp ý kiến để giúp định hình các khái niệm thiết kế và phương án khác. Cùng tham gia với chúng tôi trong việc tạo tầm nhìn bằng cách tham gia vào bất kỳ hoặc tất cả các buổi hội thảo.



Cần thêm thông tin:

Coi tại website:



www.ggcity.org/econdev/envision-willowick

Liên lạc với Ban Phát triển Cộng đồng:

Garden Grove



Mary Medrano
Associate Planner
marym@ggcity.org
714-741-5315



Lisa Kim
Community and Economic Development Director
lisak@ggcity.org
714-741-5121

Santa Ana



Vince Fregoso
Principal Planner
vfregoso@santa-ana.org
714-667-2713

PUBLIC RECORDS REQUEST LOG – AUGUST 2018

	Received	Requester	Request	Division	Due	Closed
3920	08/30/18	Joshua Roslan LexisNexis	Garden Grove, CA City Attorney's Office Attn: FOIA Administrator 11222 Acacia Pkwy Garden Grove, CA 92840-5208 Pursuant to your state freedom of information law Cal. Gov't Code Secs. 6250 to 6277, we respectfully request you to release copies...	City Clerk	09/10/18	09/04/18
3919	08/30/18	Brian Sim	All Planning, Building, and Engineering documents associated with Site Plan No. SP-022-2016, Conditional Use Permit No. CUP-065-2016 and Lot Line Adjustment No. LLA-011-2016 (10641 and 10661 Garden Grove Boulevard and 10662 Pearl Street)	Engr Services Building Serv Planning Serv	09/10/18	09/04/18
3918	08/29/18	Alina Mardesich	would like a sales tax report on all food and beverage (restaurants) in the City of Garden Grove particularly in the Grove District for the past three years	Economic Dev Revenue Management	09/10/18	09/10/18
3917	08/29/18	Jon Rabit Rabit & Associates	City Clerk's Office Garden Grove, CA RE: Public Records Act Request Dear City Clerk, Pursuant to my rights under the California Public Records Act (Government Code Section 6250 et seq.), I ask to (inspect/obtain a copy of) the followi...	City Clerk	09/13/18	09/12/18
3916	08/28/18	Hope Gippert Elytus Ltd.	I would like to request the waste agreement and rate structure between Garden Grove and Republic Services - or whoever the current hauler is. The waste agreement will state that the City has a franchised waste program, will name the chosen hauler, ...	City Clerk	09/07/18	08/29/18
3915	08/28/18	Justine Valenzuela Phantom Fireworks	Requesting all the 2018 Non profit organizations the operated a fireworks booth for 2018. Would like the	Revenue Management	09/07/18	08/29/18

PUBLIC RECORDS REQUEST LOG - AUGUST 2018

	Received	Requester	Request	Division	Due	Closed
			information to include the contact information , address, emails and or any phone numbers provided.			
<u>3914</u>	08/28/18	Mary Stepp	List of licensed plumbers in Garden Grove. Water billing for 12372 Frieda Place from January 2018 to current. Please call, no email.	Revenue Management	09/07/18	08/29/18
<u>3913</u>	08/28/18	Tai Vu	The property address is 9271 Weldon Drive, Garden Grove CA. Please, provide all building permit records for the house above. Also, include all inspection records (sign-off & inspection by city inspectors) for the construction during 2008-201...	Building Serv	09/07/18	08/29/18
<u>3912</u>	08/28/18	Evangeline Freeman <i>Level 2 Security and Automation</i>	Please email a list of new business licenses from August 2018 on the 1st or as soon as is convenient. Excel workbook format is preferred, but a word document or pdf would be fine as well. Please include owner names, phone numbers, the type of bus...	Revenue Management	09/07/18	09/10/18
<u>3911</u>	08/28/18	Je'Nai Lee	I need to know if the unit I'm renting meets code, 12672 Audrey cir Garden Grove ca 92840 and has a permit issued.	Building Serv City Clerk	09/07/18	09/04/18
<u>3910</u>	08/24/18	Thy Anh Vo <i>Voice of OC</i>	All form 700s for current city council members and mayor for 2016, 2017 and 2018.	City Clerk	08/27/18	08/24/18
<u>3909</u>	08/23/18	Rene Nevarez <i>CHC Consulting, LLC</i>	I would like to put in a request for any underground public utility records you have at the intersection of W Garden Grove Blvd and Rainbow St. The address specifically is 13001 Rainbow St., Garden Grove, CA, 92843. The types of records I need ...	Water Services Engr Services Sewer Environmental Comp Planning Serv	09/04/18	09/04/18

PUBLIC RECORDS REQUEST LOG - AUGUST 2018

	Received	Requester	Request	Division	Due	Closed
<u>3907</u>	08/23/18	Karen Romero Estrada Orange County Communities Organized for Responsible Development	RE: Public Records Act Request- City Owned Real Property Dear Clerk of the Council: Pursuant to the California Public Records Act, Government Code Sections 6250, et seq., I request that you make available to us, within ten (10) days, for ou...	Fiscal Services City Clerk	09/18/18	
<u>3906</u>	08/22/18	Michael Koster Reliant Investigations, Inc.	Dear Custodian of Records, Pursuant to provisions of section 1874 and 1875 of the California Insurance Code, insurance companies and fire or police departments can freely exchange information, notes, reports and photographs without civil or cri...	Fire Suppression Fire Prevention	09/04/18	08/23/18
<u>3905</u>	08/22/18	Larry Pineda	I'm requesting all the calls and complaints regarding Code Enforcement, Police and Fire on my property 10682 Paloma Ave, Garden Grove, CA. 92843 from 2010 to Present. Thank you	Fire Suppression Fire Prevention Police Support Serv Building Serv	09/04/18	08/29/18
<u>3904</u>	08/22/18	Adreanna Morales HP Sears	I would like to request an electronic copy of the city's current collection agency's proposal. Regards	Purchasing Revenue Management	09/04/18	08/29/18
<u>3903</u>	08/21/18	Chuck Peterson United Rentals Trench Safety	Subject: Oranewood Avenue Sewer Improvements Could I please get the Bid Results for the Above Project?	Water Services	09/04/18	08/29/18
<u>3902</u>	08/21/18	Nancy	A list of the bars that have been opened in Garden Grove, with opening/closing dates and addresses if possible. Thanks	Revenue Management	09/04/18	08/23/18
<u>3901</u>	08/20/18	NGOC NGUYEN KATELYNN	NEW MONTHLY BUSINESS LISTING OF THE CITY	City Clerk	08/30/18	08/20/18

PUBLIC RECORDS REQUEST LOG - AUGUST 2018

Received	Requester	Request	Division	Due	Closed
	NGUYEN STATE FARM				
3900	Christopher Reeve	Hello, I received a citation for a red light infraction, so am requesting a copy of Garden Grove's engineering report that was used to determine the yellow light time for vehicles going eastbound at the corner of Trask Avenue and Harbor Bouleva...	Engr Services	08/30/18	08/21/18
		August 17, 2018 Garden Grove Fire Department Attn: Records P.O. Box 3070 Garden Grove, CA 92842 714/741-5600 Denise: 714/741-5036	Fire Suppression Fire Prevention	08/30/18	08/21/18
3899	Brandy Holmes / Ms. Jody Turcotte LRI investigations	Our firm is currently investigating a fire loss that occurred in your area. Pursuant to the Insurance Co...			
3898	Thy Vo Voice of OC	All city-manager approved contracts between January 1, 2018 and August 17, 2018. Please provide records electronically.	City Clerk	08/30/18	08/21/18
3896	Xavier Maldonado	Who is the registered owner of residence? I think someone scammed me out of money for a deposit at this address. 12911 Josephine St. Garden Grove, Ca	City Clerk	08/30/18	08/20/18
3894	Frank Trinidad Odic Environmental	We are doing an environmental site assessment on the property and would like to know if there are any records in regards to underground/aboveground storage tanks, hazardous materials, hazardous waste and/or any clarifiers on the property located a...	Fire Suppression Fire Prevention	08/27/18	08/23/18

PUBLIC RECORDS REQUEST LOG - AUGUST 2018

	Received	Requester	Request	Division	Due	Closed
3893	08/16/18	Alan Adan Pacheco Malagon AESCO Technologies, Inc.	Requesting information regarding the following 2 properties for the purpose of a Phase I Environmental Site Assessment: 9915 Garden Grove Blvd., Garden Grove, CA 92844 9943 Garden Grove Blvd., Garden Grove, CA 92844 Records containing infor...	Fire Suppression Fire Prevention	08/27/18	08/23/18
3891	08/16/18	Jennifer Weatherup Hensley Law Group	Claims filed with the City of Garden Grove related to incidents involving Bird (https://www.bird.co/), Lime (http.s://www.limebike.com/electric-scooter), and other motorized scooters between 7/1/17 and the present.	Risk Management	08/27/18	08/20/18
3890	08/16/18	Jennifer Weatherup Hensley Law Group	Claims filed with the City of Garden Grove related to incidents involving Bird (https://www.bird.co/), Lime (http.s://www.limebike.com/electric-scooter), and other motorized scooters between 7/1/17 and the present.	Risk Management	08/27/18	08/20/18
3889	08/16/18	Brian Johnson	Am i allowed to pick up my birth certificate at city hall?	City Clerk	08/27/18	08/16/18
3888	08/16/18	TAE JU PAK	Copy of the Fire Department Incident Report for the house fire that occurred on 08/10/18 at 12931 1/2 Louise Street in Garden Grove CA	Fire Suppression Fire Prevention	08/27/18	08/21/18
3887	08/15/18	Gladys Rosario Lawyers' Committee for Civil Rights of the San Francisco Bay Area	Please see attached letter providing an explanation and details of the request regarding vehicle impoundment and towing.	Police Support Serv Police Admn Serv Police Mgmt	10/15/18	
3886	08/15/18	Mark Fisher LGC Real Estate, LLC	Public Records Request City Clerk Department Please process the request per the Public Records Act California Government Code § 6250. Requesting records of Tax Delinquent for Individual	City Clerk	08/27/18	08/15/18

PUBLIC RECORDS REQUEST LOG - AUGUST 2018

	Received	Requester	Request	Division	Due	Closed
			Property.			
			DESCRIBE THE SPECIFIC PUBLIC R...			
3885	08/14/18	Krystina Bennett Cass WEM	Commercial garbage rate sheet for 2018. In the past we have been sent the inter-department memorandum regarding the Republic trash rates with Attachment A which provides the pricing details.	City Clerk	08/24/18	08/15/18
3884	08/14/18		Name of the new owner or outcome of a property auction done July 9th 2018 @3:00pm regarding property 13351 McEvoy Ln Garden grove 92843	City Clerk	08/24/18	08/15/18
3882	08/10/18	Bela Christensen Accutrend Data Corporation	All new business licenses filed in July of 2018.	City Clerk	08/20/18	08/10/18
3881	08/10/18	THU HA LE FARMERS INSURANCE	Hello, I am looking for any building update for building located at 10862 Garden Grove Blvd. Garden Grove, Ca 92843 Thank you very much	Building Serv	08/20/18	08/10/18
3880	08/10/18	Evangeline Freeman Level 2 Security and Automation	Please send the list of new business licenses obtained in July 2018. Excel workbook format would be preferable, or a pdf if that is not possible. Please include the names of business owners, phone numbers, and email addresses if available.	City Clerk	08/20/18	08/10/18
3879	08/10/18	Gemma Magbulos La Rocque Better Roofs, Inc	Please email copy of fire incident report #2018-809425 prepared by Shane Waldscmidt regarding La Jolla Plaza fire incident on 18:36:40, WED 8/8/18.	Fire Suppression Fire Prevention	08/20/18	08/15/18
3878	08/10/18		Please provide any planning or building restrictions for this property: 12921 Gilbert Street, Garden Grove, CA 92841	Planning Serv Building Serv	08/20/18	08/15/18
3877	08/10/18		Hi,	Fire Suppression	08/20/18	08/15/18

PUBLIC RECORDS REQUEST LOG - AUGUST 2018

Received	Requester	Request	Division	Due	Closed
		Please provide permit records and blueprints for this property, and any planning, zoning or fire code violations and the most recent fire inspection dates (if available): 12921 Gilbert St, Garden Grove, CA 92841	Fire Prevention Building Serv		
3876	Sandy Valladares Level2 Security & Automation	We are looking to obtain a list of new business for the month of July. Please include owner name, business name, address and phone number.	City Clerk	08/20/18	08/10/18
3875		12931 7th St. Garden Grove, CA 92840 In 1988 this property was taken into a closed session regarding two non-permitted units being built on the property. I'm looking for the results of the closed session, please.	City Clerk	09/04/18	08/29/18
3874	Jim Lissner	REF: Request #2818 8-9-18 For Ms. Kehn: I've now had more time to go thru the documents you dropped to me in late June and have some follow up requests as well as two brand new requests. The Brand New Requests B. For each "interse...	Engr Services Community Policing	09/04/18	08/27/18
3873	Mai Nguyen Farmers Insurance	Hello, I am looking for any building update for building locate at 13861 Newhope se Garden Grove CA 92843. Thank You	Building Serv	08/20/18	08/09/18
3872	James	Hi,	Building Serv	08/20/18	08/09/18

PUBLIC RECORDS REQUEST LOG -- AUGUST 2018

	Received	Requester	Request	Division	Due	Closed
			Please provide permit records for this property. 9642 Mallard Ave, Garden Grove, CA 92844 APN: 098-493-03 Thanks			
<u>3871</u>	08/08/18	Allen Bourgeois <i>Traffic Works</i>	I am requesting copies of the signal timing plan, the signal as-built plans, and the phase diagram, that were current and in effect on 7-15-2016 for the intersection of Newland Street and Garden Grove Blvd. If possible I would prefer to receive t...	Engr Services	08/20/18	08/09/18
<u>3870</u>	08/08/18	Phuong Nguyen	ALL PERMITS FOR 9461 TRASK AVE	Building Serv	08/20/18	08/09/18
<u>3869</u>	08/08/18	Jameel Pickens <i>Zoning Info</i>	RE: 13946 Erin St Copies of Certificates of Occupancy, open or outstanding building, zoning, fire code violations, current or upcoming road projects that would affect right of way of property	Engr Services Fire Suppression Fire Prevention Building Serv	08/20/18	08/20/18
<u>3868</u>	08/08/18		Requesting information on intake G001801, held at OC Humane Society. Requesting all notes and medical records, Current location or outcome.	Street Maint	08/20/18	08/09/18
<u>3866</u>	08/08/18	Scott McDonald <i>Fire Cause Analysis</i>	Hello! We would like to request a fire incident report for the fire referenced in the attached document. Location: 11792 Stephanie Lane Date of Incident: 06/30/2018 Thank you.	Fire Suppression Fire Prevention	08/20/18	08/09/18
<u>3865</u>	08/08/18		1) Request correspondence (including email) from employer (City of Garden Grove) to represented employee groups (unions) regarding changes to policies	Information Systems Human Resources	08/20/18	08/20/18

PUBLIC RECORDS REQUEST LOG - AUGUST 2018

	Received	Requester	Request	Division	Due	Closed
			and procedures. 2) Request communications (including email) between City of Garden Grove and ...			
<u>3864</u>	08/08/18	Alex Kazmierczak <i>Biomechanical Research and Testing, LLC</i>	Request for traffic signal timing and phasing records at the intersection of Knott St. and Chapman Ave. in Garden Grove, CA on 03/17/17 around 6:50 a.m.	Engr Services	08/20/18	08/09/18
<u>3863</u>	08/08/18	Ryan	Could i please get the building permits and any blueprints on file for 11917 Brookhaven St, Garden Grove, 92840 Thank you.	Building Serv	08/20/18	08/09/18
<u>3862</u>	08/06/18	Jackie Verbka <i>AECOM</i>	Interested in learning if there are any permits on file and any waste water discharge violations for commercial property located at 9222 Trask Avenue, Garden Grove, CA.	Environmental Comp	08/16/18	08/09/18
<u>3861</u>	08/06/18	Jackie Verbka <i>AECOM</i>	Does the City of Garden Grove Water Services Division provide water service and sanitary sewer service to the commercial property located at 9222 Trask Avenue, Garden Grove, CA?	Revenue Management	08/16/18	08/09/18
<u>3860</u>	08/06/18	Renan Zepeda <i>Partner Engineering and Science, Inc.</i>	Hello I would like to know if the following property has any open planning, zoning or fire code violations and the most recent fire inspection dates (if available): Property: 13261 Garden Grove Blvd. Garden Grove California 92843 Please s...	Building Serv Fire Suppression Fire Prevention	08/16/18	08/09/18
<u>3859</u>	08/06/18	Jackie Verbka <i>AECOM</i>	Fire department responses to 9222 Trask Avenue in the last 25 years.	Fire Suppression Fire Prevention	08/16/18	08/09/18

PUBLIC RECORDS REQUEST LOG – AUGUST 2018

	Received	Requester	Request	Division	Due	Closed
<u>3858</u>	08/06/18	John Palme <i>Jake's Fireworks</i>	Copies of all approved 2018 Fireworks Permits	Fire Prevention Fire Admin Revenue Management	08/16/18	08/15/18
<u>3857</u>	08/06/18	Neil Kuemerle <i>Odic Environmental</i>	Please provide finalized building permit records for 11541 Salinaz Ave dating back to original development.	Building Serv	08/16/18	08/06/18
<u>3856</u>	08/06/18	Chris Davis <i>Market Force One</i>	Requesting the July 'new business list' in EXCEL format	City Clerk	08/16/18	08/06/18
<u>3855</u>	08/06/18	Jameel A Pickens <i>Zoning Info</i>	9641, 9643, 9711, 13962, Westminster Blvd Copies of Certificates of Occupancy any open or outstanding building, zoning, fire code violations	Fire Suppression Fire Prevention Building Serv	08/16/18	08/09/18
<u>3854</u>	08/06/18	Jameel A Pickens <i>Zoning Info</i>	RE: 11502, 11522, 11532, 11552, 11562, 11572, 11592, 11602, 11612, 11622, 11642, 11652, 11662, 11672, 11682, 11702, 11712, 11732, 11742, 11762, 11782, 11802, 11822, 11842, 11852, 11851, 11841, 11821, 11801, 11781, 11761, 11741, 11731, 11711, 11701...	Fire Suppression Fire Prevention Building Serv	08/16/18	08/09/18
<u>3853</u>	08/06/18		I am requesting all incomes and outcomes of animals from OC Humane Society for the period of 7/1/2018 - 7/31/2018. This would include all July intakes (strays, owner surrenders, returns, transfers in) and all July adoptions, redeemed, transfers ou...	Street Maint	08/16/18	08/09/18
<u>3852</u>	08/06/18	Emily Lauder <i>Cerrell Associates</i>	Hi there, I would like the contact information for City Manager, Scott C. Stiles (phone number and email) as well as the name and contact information for his assistant(s). Thank you so much. Best, Emily	City Clerk	08/16/18	08/06/18
<u>3851</u>	08/06/18	Johnny Ta	Can you please send me the listing for new businesses	Revenue	08/16/18	08/06/18

PUBLIC RECORDS REQUEST LOG – AUGUST 2018

	Received	Requester	Request	Division	Due	Closed
		ADT	for the month of July, thank you.	Management		
3850	08/06/18	Mary Cook	Birth certificate for Mary Clare O'Loughlin born 1956	City Clerk	08/16/18	08/06/18
3849	08/06/18	Aaron Juarez <i>Draw 4 Me Fire Etc.</i>	Good morning, I am looking for the existing overhead fire sprinkler plans for 12361 Chapman ave. The owner is doing a tenant improvement and we need to review the existing fire system.	Building Serv	08/16/18	08/06/18
3848	08/02/18	Colin Donohue <i>Partner ESI</i>	Address: 13261 Garden Grove Boulevard Building - original permits, certificates of occupancy, underground tank, above ground tank, clarifier, spray booth. Fire Department - Hazardous materials, underground tank, above ground tank, clarifier, sp...	Fire Suppression Fire Prevention Building Serv	08/13/18	08/06/18
3847	08/02/18	Denise Salado <i>The Barnes Firm</i>	Copies of ambulance medical and billing records for date of injury 08/16/2017 to present.		08/13/18	08/13/18
3846	08/01/18	kathleen winter	Hi, I am requesting a list of any internet cafe's. Also would like information on how to get one started. Thank you, Kathleen Winter	Revenue Management	08/13/18	08/06/18
3845	08/01/18	Loren J. Bialik <i>Mazel Equities National Associates</i>	Subject: California Public Records Act Denise Kehn, Records Specialist: Under the Public Records Act we request access and copies of the following: 1. Unclaimed or outstanding checks including dates, names, last addresses and amounts due ...	Fiscal Services	08/13/18	08/10/18
3844	08/01/18	Sarah Phosouvanh	Hi, I am requesting for a fire report.	Fire	08/13/18	08/06/18

PUBLIC RECORDS REQUEST LOG - AUGUST 2018

	Received	Requester	Request	Division	Due	Closed
		Metropolitan Reporting Bureau	Name: Stonebridge Realty Advisors Loss date: 07/25/2018 Location: 2005 Harbor Blvd Report # unknown	Suppression Fire Prevention		



Memorandum

DATE: September 14, 2018
TO: Member Agencies – MWDOC Divisions Two & Three
FROM: Larry Dick, Director – Division Two
Wayne S. Osborne, Director – Division Three
SUBJECT: Monthly Water Usage Data, Tier 2 Projection & Water Supply Information

The attached figures show the recent trend of water consumption in Orange County (OC), an estimate of Imported Water Sales for MWDOC, and selected water supply information.

- OC Water Usage, Monthly by Supply OCWD Groundwater was the main supply in July.
- OC Water Usage, Monthly, Comparison to Previous Years Water usage in July 2018 was above average compared to the last 5 years. We are continuing to see slight increases in overall water usage compared to the previous two Fiscal Years. In June 2016, all water conservation became voluntary for MWDOC agencies and the Great California Drought was declared over by the Governor in April 2017.
- Historical OC Water Consumption Orange County M & I water consumption is estimated to be 540,000 AF in FY 2018-19 (*this includes ~15 TAF of agricultural usage and non-retail water agency usage*). This is about 15,000 AF more than FY 2017-18 and is about 36,000 AF more than FY 2016-17. Water usage per person is projected to be slightly higher in FY 2018-19 for Orange County at 155 gallons per day (This includes recycled water). Although OC population has increased 20% over the past two decades, water usage has not increased, on average. A long-term decrease in per-capita water usage is attributed mostly to Water Use Efficiency (water conservation) efforts. O.C. Water Usage for the last three Fiscal Years is the lowest since the 1982-83 Fiscal Year (FY1982-83 was the third wettest year on record).

Water Supply Information Includes data on Rainfall in OC; the OCWD Basin overdraft; Northern California and Colorado River Basin hydrologic data; the State Water Project (SWP) Allocation, and regional storage volumes. The data have implications for the magnitude of supplies from the three watersheds that are the principal sources of water for OC. Note that a hydrologic year is Oct. 1st through Sept. 30th.

- Orange County's accumulated rainfall through August was well below average for this period. Water year to date rainfall in Orange County is 3.66 inches which is 29% of normal.
- Northern California accumulated precipitation through August was around 84% of normal for this period. Water Year 2017 was the wettest water year on record. The Northern California snowpack was 43% of normal as of April 1st. The State of California was in a declared Drought Emergency that started January 2014 and ended in April of 2017. As of late August, 47.58% of California is experiencing moderate to extreme drought conditions while 86.22% of the state is experiencing abnormally dry conditions. The State Water Project Contractors Table A Allocation has increased to 35% as of late May.
- Colorado River Basin accumulated precipitation through late August was 69% average for this period. The Upper Colorado Basin snowpack was 71% of normal as of April 3. Lake Mead and Lake Powell combined have about 58% of their average storage volume for this time of year and are at 42.6% of their total capacity. If Lake Mead's level falls below a "trigger" limit 1,075 ft. at the end of a calendar year, then a shortage will be declared by the US Bureau of Reclamation (USBR), impacting Colorado River water deliveries to the Lower Basin states. As of late August, Lake Mead levels were 3.5' above the "trigger" limit. The USBR predicts that the start of 2019 will not hit the "trigger" level but there is a 52% chance that the trigger level will be hit in 2020 and a 64% chance in 2021.



Fig. 1 OC Water Usage, Monthly by Supply
with projection to end of fiscal year

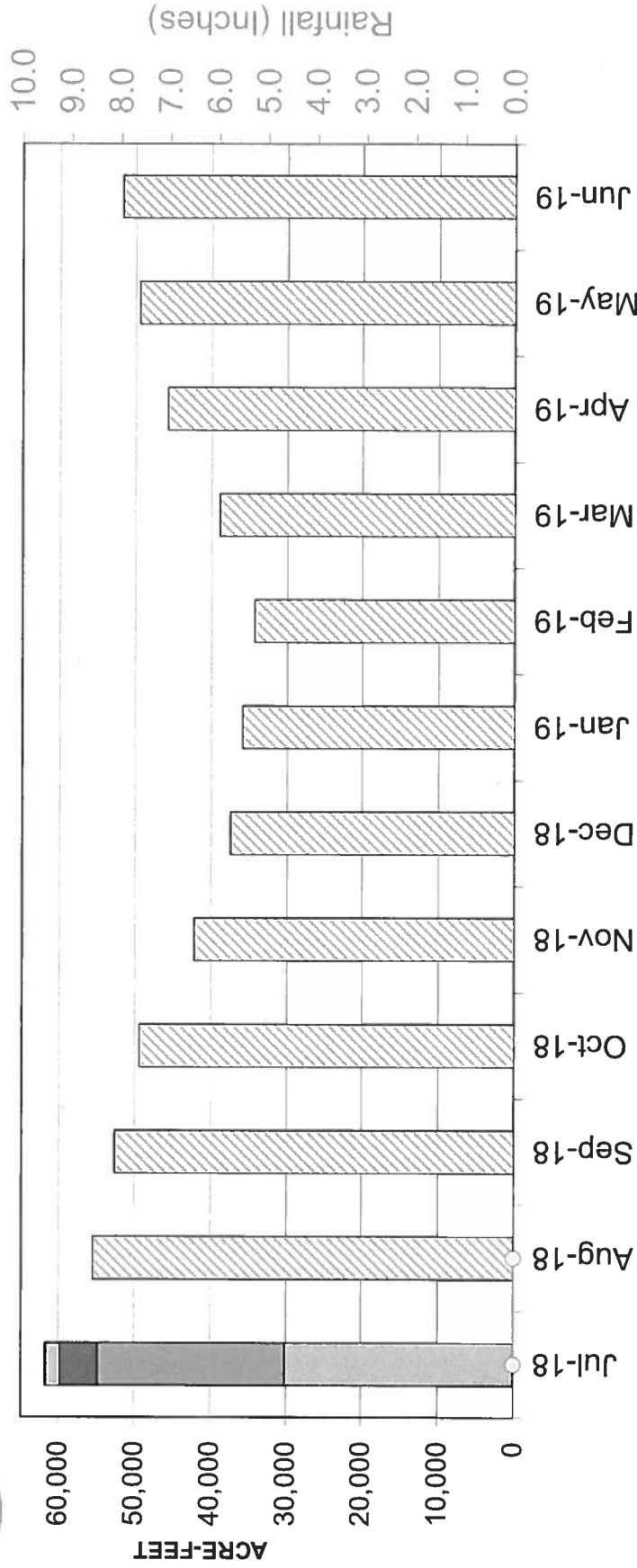

[1] Imported water for consumptive use. Includes "In-Lieu" deliveries and CUP water extraction. Excludes "Direct Replenishment" deliveries of spreading water, "Barrier Replenishment" deliveries, and deliveries into Irvine Lake.
 [2] GW for consumptive use only. Excludes In-Lieu water deliveries and CUP water extraction that are counted with Import. BPP in FY '17-18 is 75%.
 [3] MWDOC's estimate of monthly demand is based on the projected FY 15-16 "Retail" water demand and historical monthly demand patterns.
 [4] Total water usage includes IRWD groundwater agricultural use and usage by non-retail water agencies.



Fig. 2 OC Monthly Water Usage [1]: Comparison to Last 4 Fiscal Years

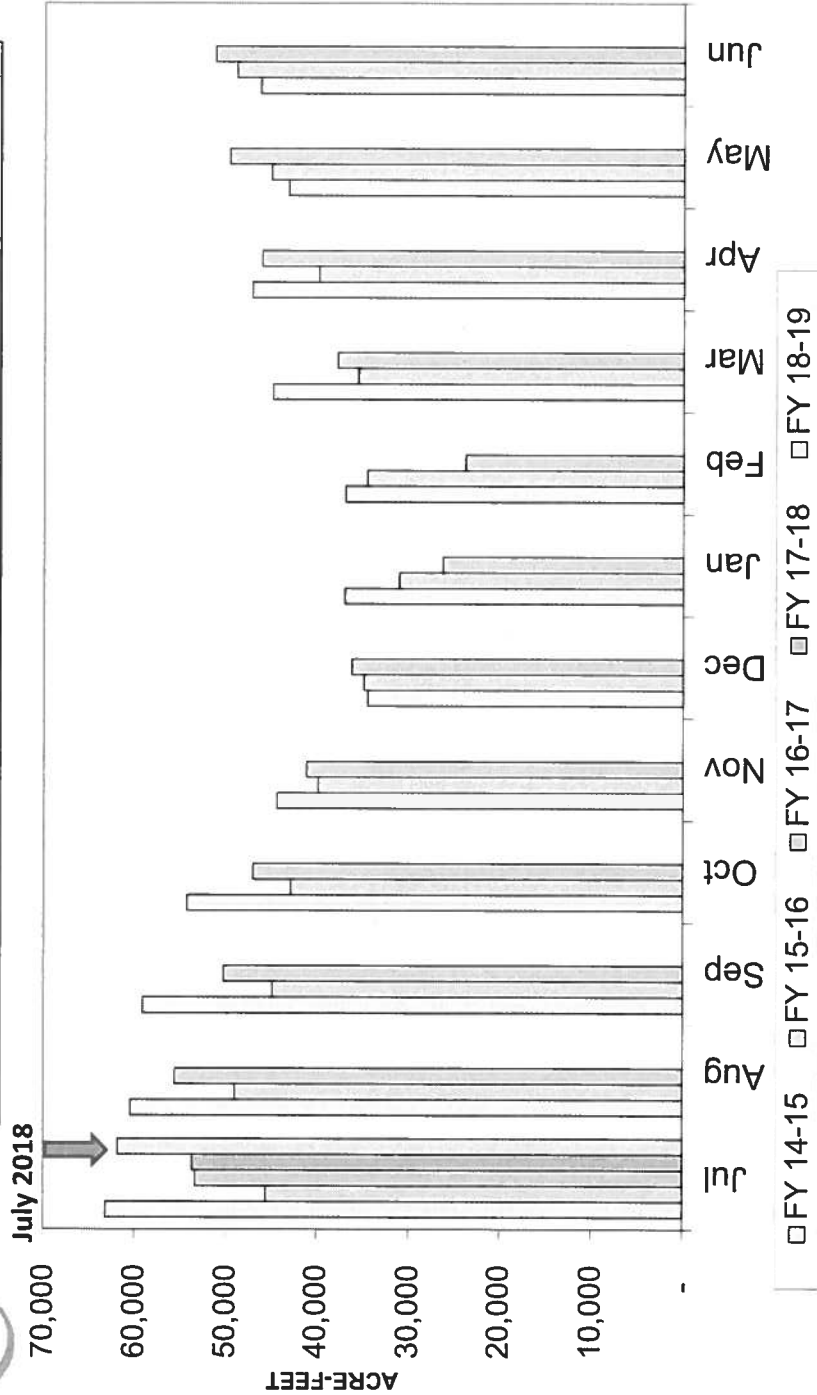

Partial Year Subtotals

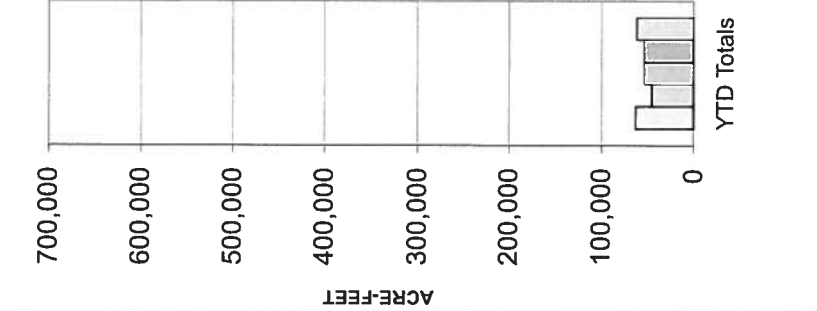

[1] Sum of Imported water for consumptive use (includes "In-Lieu" deliveries; excludes "Direct Replenishment" and "Barrier Replenishment") and Local water for consumptive use (includes recycled and non-potable water and excludes GWRS production). Recent months numbers include some estimation.

Accumulated Precipitation

for the Oct.-Sep. water year, through August 2018

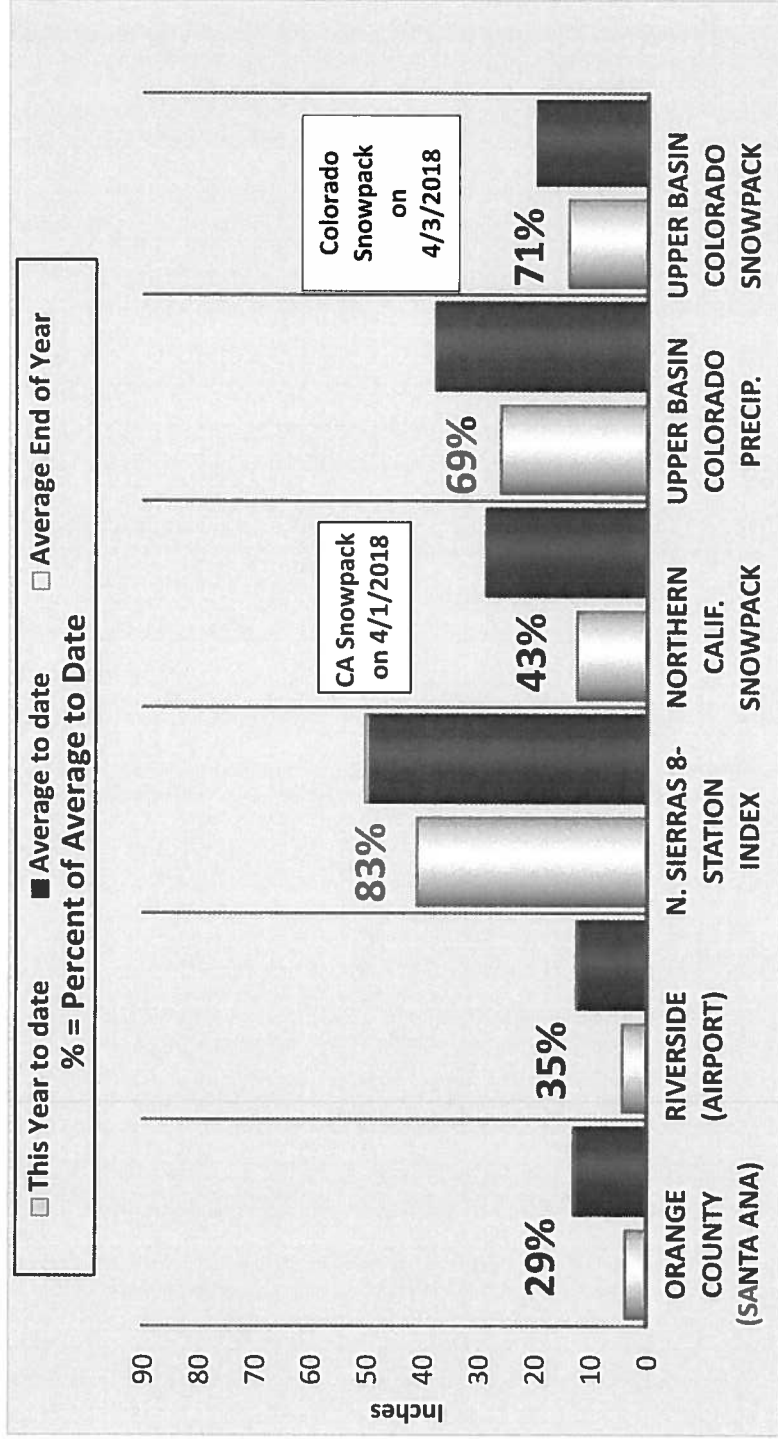

* The date of maximum snowpack accumulation (April 1st in Northern Calif. , April 15th in the Upper Colorado Basin) is used for year to year comparison.

Accumulated Overdraft of the OCWD Groundwater Basin as of July 2018

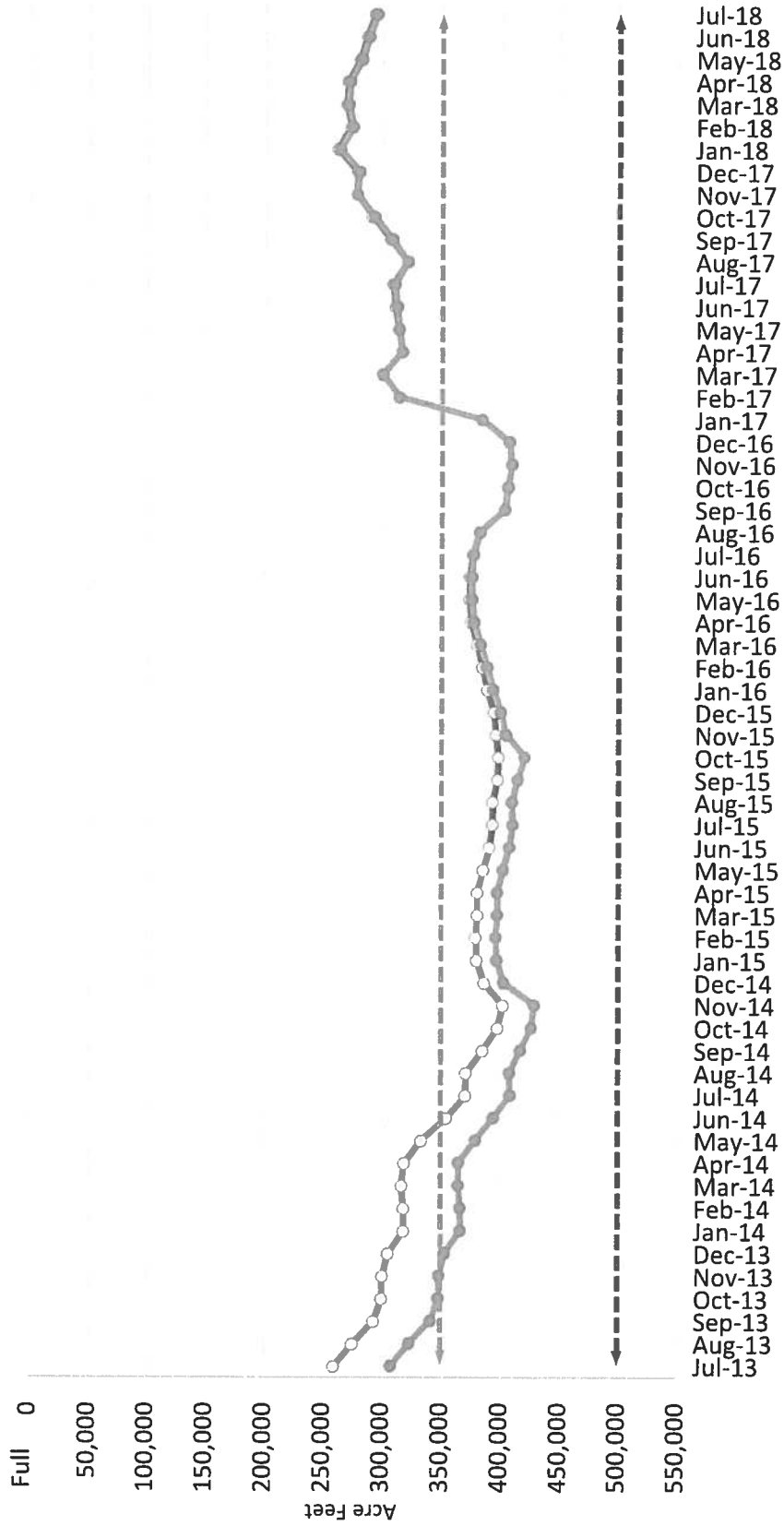

	Jul-17	Aug-17	Sep-17	Oct-17	Nov-17	Dec-17	Jan-18	Feb-18	Mar-18	Apr-18	May-18	Jun-18
AO (AF)	308,488	321,131	306,280	290,800	277,691	278,056	261,521	272,475	268,752	269,889	280,329	286,163
AO w/CUP removed (AF)	310,216	321,131	308,007	292,522	277,691	279,776	263,237	274,188	270,463	271,601	282,041	287,869
AO (AF)	292,869											
AO w/CUP removed (AF)	294,572											

Source of data = OCWD monthly Water Resources Report in Board meeting packet



State Water Project, Colorado River, and MWD Reservoir Storage
as of September 4, 2018

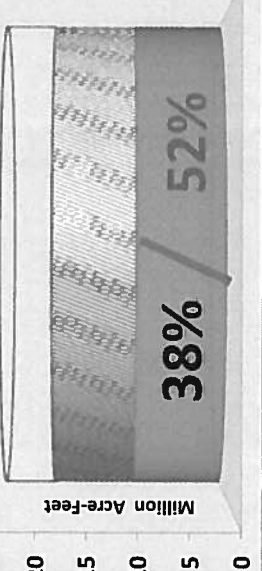
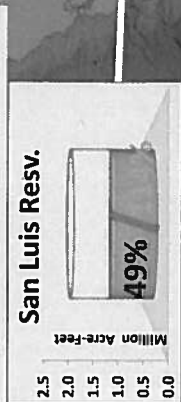
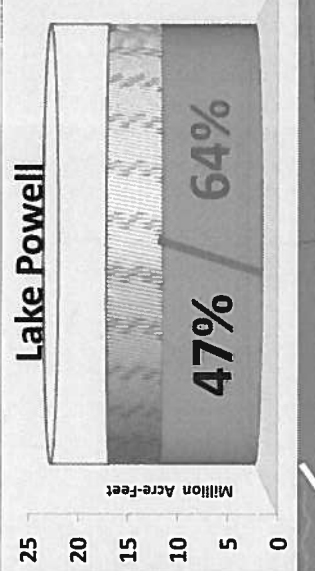
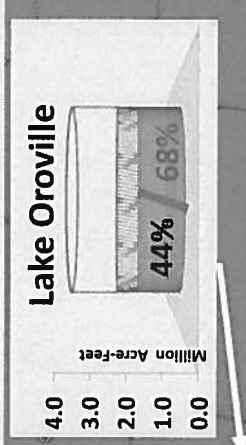
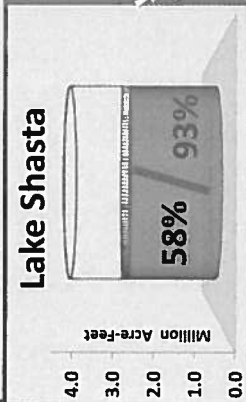

Prepared by the Municipal Water District of Orange County
September 2018



SWP TABLE A ALLOCATION

FOR STATE WATER PROJECT CONTRACTORS

Final 2019: ???

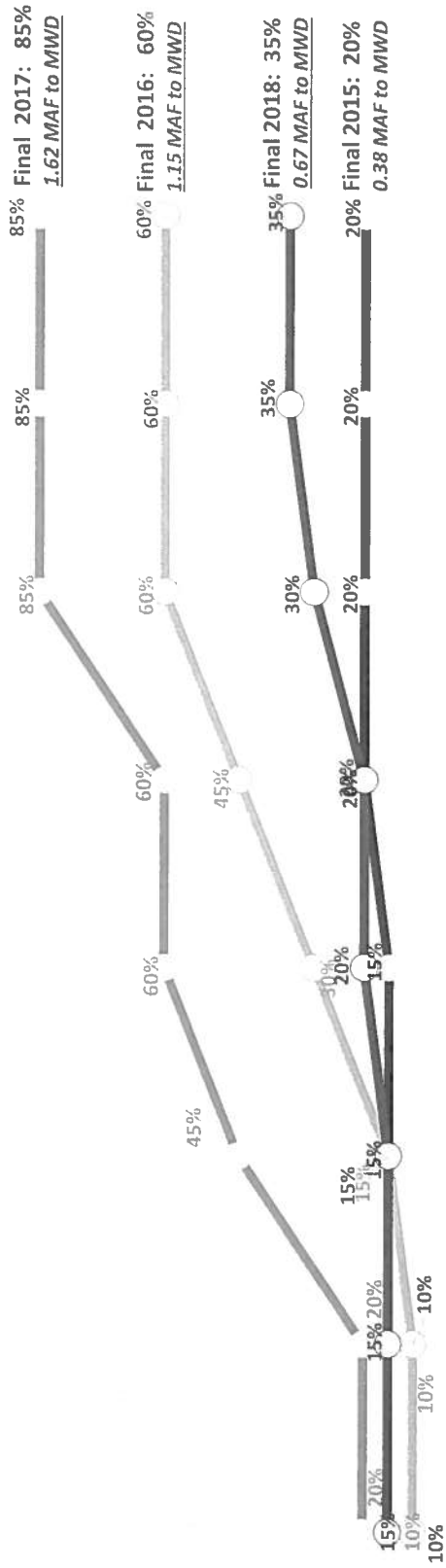

Nov. Dec. Jan. Feb. Mar. Apr. May Jun.

Water Year 2015 Water Year 2016 Water Year 2017 Water Year 2018 Water Year 2019

Historical Northern California April 1st Peak Snow Water Equivalent

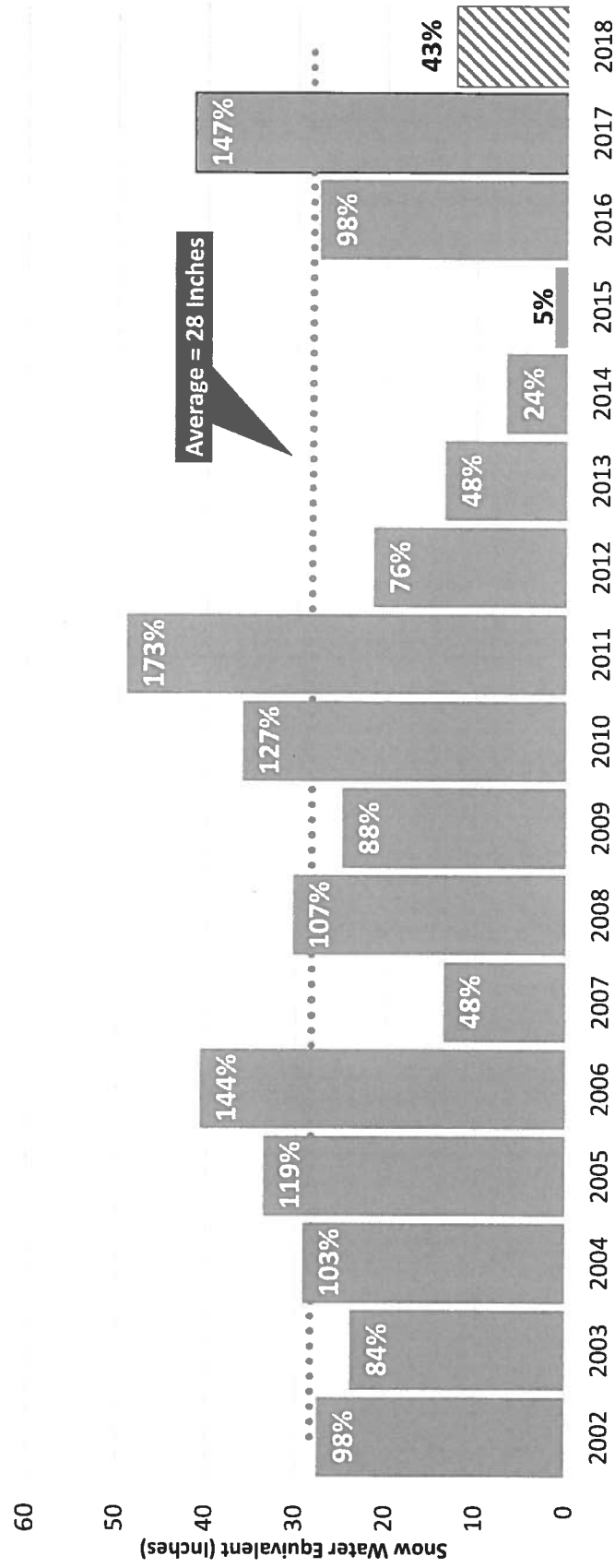

Historical Colorado Basin April 15th Peak Snow Water Equivalent

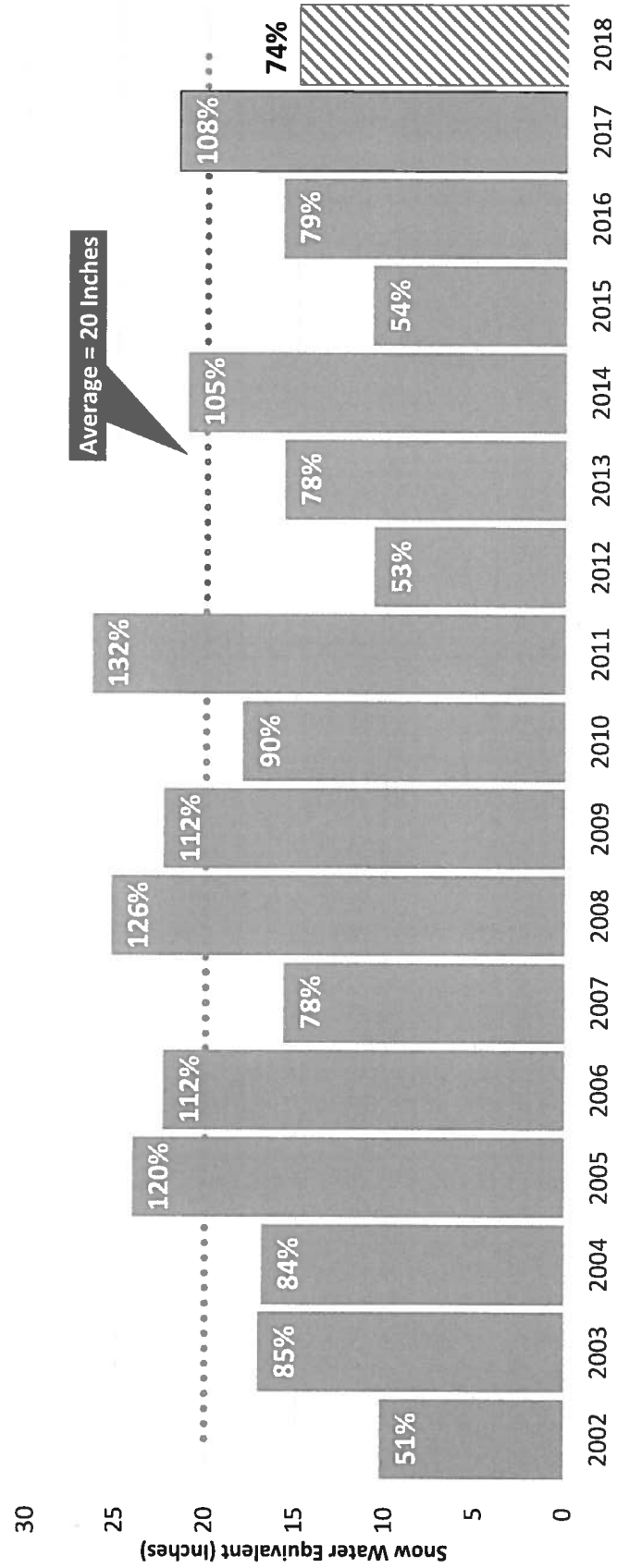



Lake Mead Levels: Historical and Projected projection per USBR 24-Month Study

■ Historical □ Projected

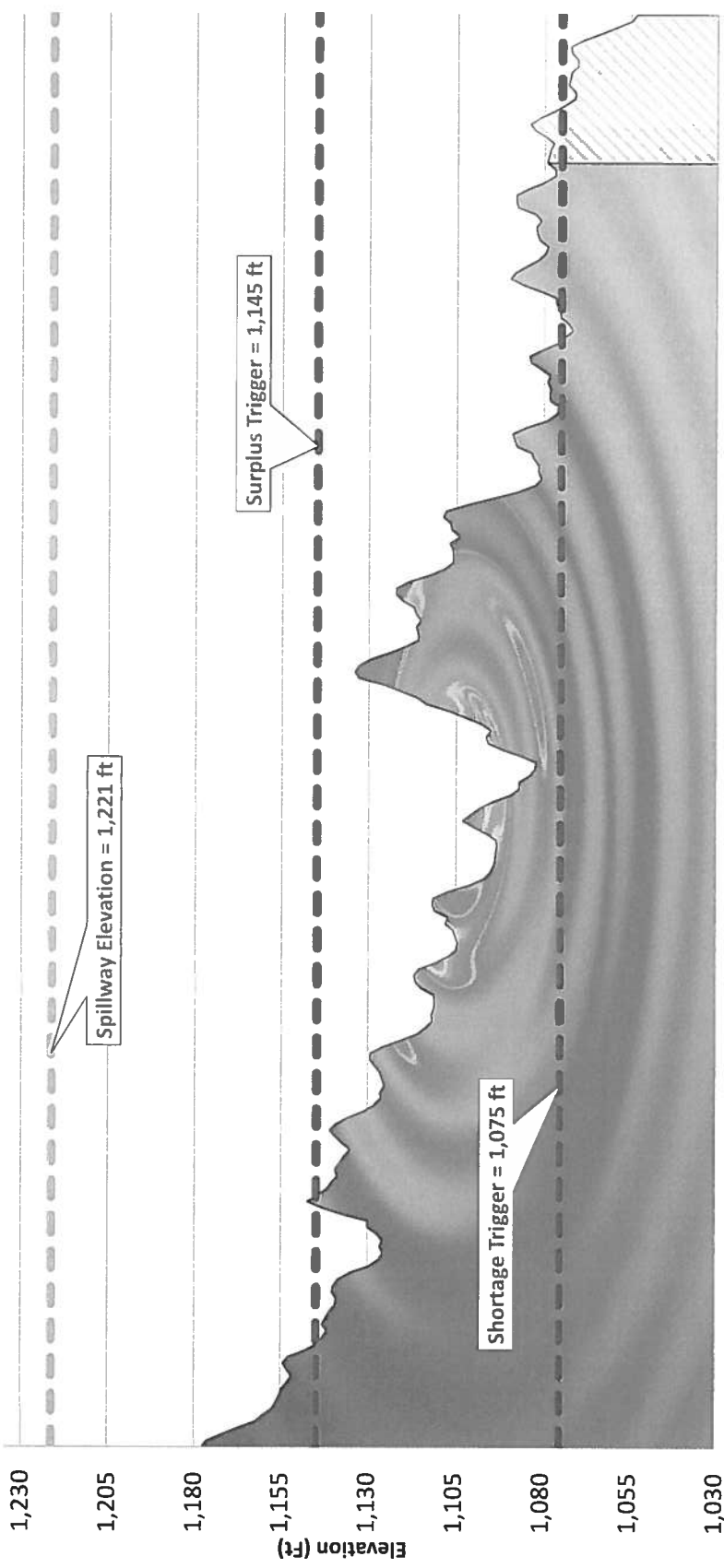

Jan 02 Jan 03 Jan 04 Jan 05 Jan 06 Jan 07 Jan 08 Jan 09 Jan 10 Jan 11 Jan 12 Jan 13 Jan 14 Jan 15 Jan 16 Jan 17 Jan 18 Jan 19 Jan 20



Lake Powell Levels: Historical and Projected projection per USBR 24-Month Study

■ Historical □ Projected

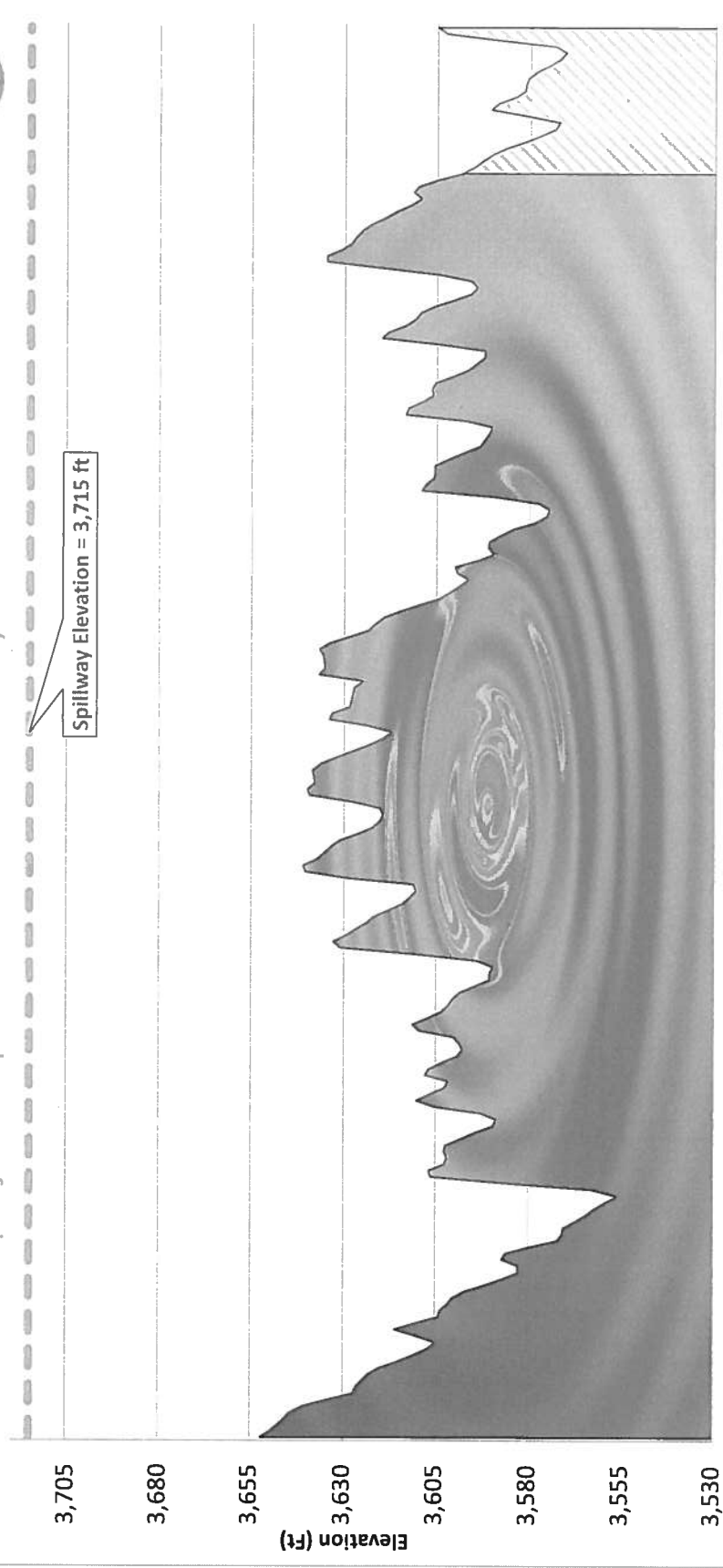

Jan 02 Jan 03 Jan 04 Jan 05 Jan 06 Jan 07 Jan 08 Jan 09 Jan 10 Jan 11 Jan 12 Jan 13 Jan 14 Jan 15 Jan 16 Jan 17 Jan 18 Jan 19 Jan 20



Lake Mead Historical Water Elevation Level



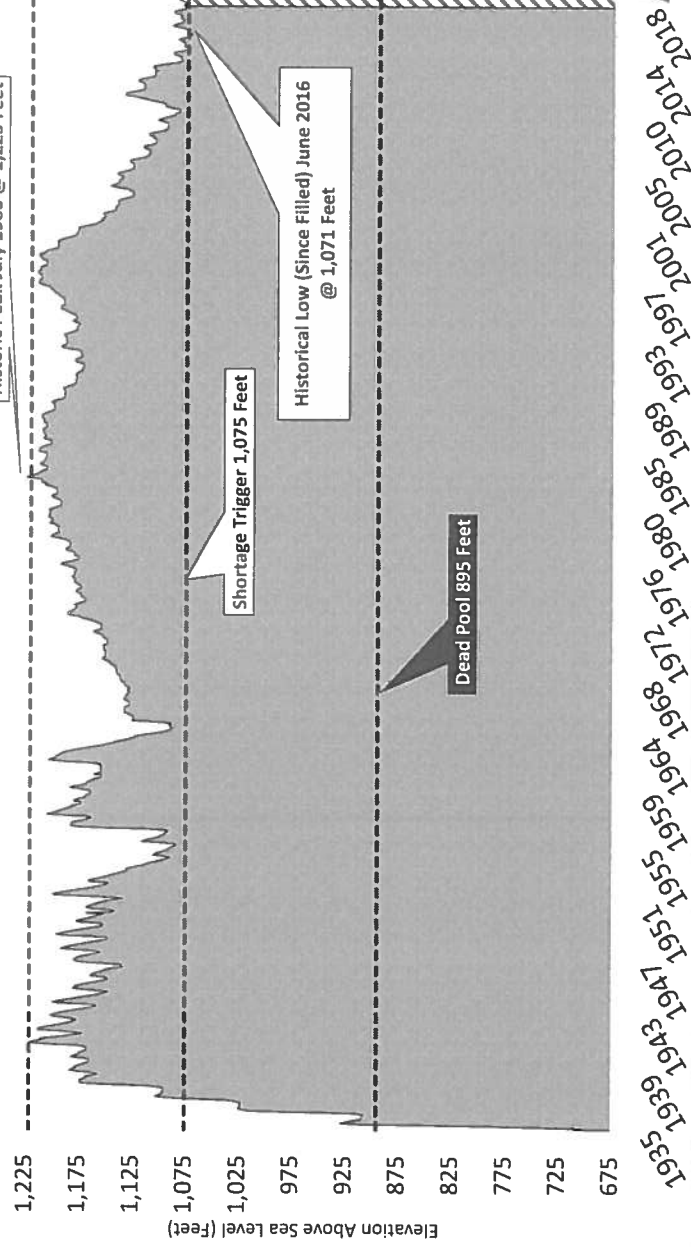

Intake Tower

Hoover Dam



WEEKLY MEMO 9-20-18

**SOCIAL MEDIA
HIGHLIGHTS**

Date Sent	Total Reach	Reactions	Comments	Engagement	Clicks	
	<p>Garden Grove City Hall Free cheeseburgers on National Cheeseburger Day!</p>	3k	48	9	9%	327
<p>In celebration of National Cheeseburger Day, several establishments known for their burgers are offering special deals to patrons. Garden Grove's own Red Robin Gourmet Burgers, located at 12007 Harbor Blvd., is giving away \$5 cheeseburgers with the purchase of a beverage. Think #BiGG - Buy in #GardenGrove!</p>						
<p>Find more meal deals and local business participants at https://www.usatoday.com/story/money/nation-now/2018/09/18/national-cheeseburger-day-2018-get-free-food-and-discounts-tuesday/1275508002/.</p>						
<p>#gg1956 #nationalcheeseburgerday #mealdeals Red Robin Gourmet Burgers</p>						
						
<p>(Post) September 18, 2018 10:50 am</p>						
	<p>Garden Grove City Hall Congratulations to our very own Garden Grove Unified School District's continued academic accomplishment success!</p>	156	9	-	44%	96
<p>#GG1956 #GardenGrove #GGUSD Pride</p>						
						
<p>(Post) September 13, 2018 1:03 pm</p>						

Date Sent Total Reach Reactions Comments Engagement Clicks



Garden Grove City Hall

Did you know...

674 8 - 3% 19

...there are approximately 300,000 people in Orange County who are at risk of hunger each month? And, more than 117,000 of those at risk are children.

This month, the City is partnering with Second Harvest Food Bank of Orange County to bring awareness of hunger in OC. Both agencies have hosted free mobile food pantry events in the community, and continue to do so in an effort to stop the hunger.

For more information, visit https://www.feedoc.org/. #GG1956 #GardenGrove #SecondHarvestFoodBank #EndHungerinOC

Home - Second Harvest Food Bank of Orange County

(Post) September 17, 2018 8:23 am



Garden Grove City Hall

West Garden Grove Safe Routes to School Event & Bike Rodeo this Friday, September 21, 3:00 p.m. to 5:00 p.m., at Bell Intermediate, 12345 Springdale Street!





987 7 2 3% 30



Come out for a presentation of West #GG #SafeRoutes to School Walk Audit, bike skills class, helmet fittings, giveaways, a motor rodeo, and a chance to meet Shadow Scout, Darth Vader, Qi'Ra, Imperial Officer, Han Solo, Leia Organa, and Rey from Star Wars.



#ReImagineGG #GGOpenStreets #GG1956 #GardenGrove







(Post) September 19, 2018 10:52 am



Date Sent	Total Reach	Reactions	Comments	Engagement	Clicks		
	Garden Grove City Hall	The King lives on!	945	6	-	3%	35
The 19th annual Elvis Festival returned to Historic Main Street Garden Grove, CA on August 26, 2018 to celebrate the music, life, and legacy of Elvis Presley. GGTV3 Reporter Rachel Jordan shares rockin' story.							
Be sure to share and subscribe to Garden Grove TV 3 channel!							
							
(Post) September 18, 2018 2:19 pm							
	Garden Grove City Hall	Did you know #September is California Pedestrian Safety Month?	588	6	1	3%	15
In an effort to reduce the number of pedestrians being killed and injured, Garden Grove Police Department's Accident Reduction Team is conducting a citywide bicycle and pedestrian operation tomorrow, September 14, 7:00 a.m. to 3:00 p.m.							
#SafeStreetsGG #StayAlertGG #OTS #GG1956 #GardenGrove California Office of Traffic Safety							
September is California Pedestrian Safety Month City of Garden Grove							
(Post) September 13, 2018 2:43 pm							
	Garden Grove City Hall	With input from the community, the City of Garden Grove's Information Technology Department has created a new website, ggcity.org . It's designed to be easily accessible by all users on all devices. We couldn't begin to tell you all of the cool things you'll find there. Watch Garden Grove TV 3's video below and log on to ggcity.org today. #GG1956 #GardenGrove	1.2k	4	2	3%	58
							
(Post) September 17, 2018 7:12 pm							

Date Sent	Total Reach	Reactions	Comments	Engagement	Clicks	
	Garden Grove City Hall	112	2	-	11%	15
<p>Just a friendly reminder about tomorrow's Walks with Parks -- Take a walk with Orange County United Way as they stroll through #GardenGrove, taking in the sights and sounds of downtown. Meet at Garden Grove City Hall, located at 11222 Acacia Parkway, at 8:00 a.m.</p>						
<p>#GG1956 #WalkwithParks #LocalWalk #DowntownGardenGrove</p>						
						
<p>(Post) September 14, 2018 11:08 am</p>						
	Garden Grove City Hall	83	-	1	6%	7
<p>Sewer construction has begun on State College and Cerritos. If you are commuting through that area, be sure to give yourself extra time.</p>						
<p>Orange County Sanitation District #GG1956 #GardenGrove #OCSDStateCollege</p>						
<p>Orange County Sanitation District</p>						
<p>(Post) September 17, 2018 12:52 pm</p>						

Date Sent	Total Reach	Reactions	Comments	Engagement	Clicks
 <p>Garden Grove Fire Department It's currently 81 degrees F in GG. This means after 30 minutes to an hour inside a vehicle, the temperature can be between 114 & 123. Please don't leave your pets or people in the vehicle while you're running your errands.</p> <p>Pic: Garden Grove Police Department</p>  <p>(Post) September 15, 2018 2:02 pm</p>	1.5k	58	2	5%	35

 <p>Garden Grove Fire Department What are you guys doing on 9/29?</p> <p>If you're going to be in or near Garden Grove that day & you don't have an emergency preparedness plan, this meet & greet with our #CERT team is for you. Yes, you!</p> <p>#gardengrovefire Garden Grove Police Department Garden Grove City Hall Garden Grove Public Works Department Garden Grove CERT</p>  <p>(Post) September 19, 2018 8:40 pm</p>	759	17	2	6%	57
---	-----	----	---	----	----

Date Sent	Total Reach	Reactions	Comments	Engagement	Clicks
 <p>Garden Grove Police Department ***Update*** The 46-year-old male suspect died from his injuries at 3:38PM. The 43-year-old female victim had minor injuries. The officer was not harmed. OCDA major investigations team will be conducting the shooting investigation. For the full press release: http://bit.ly/GGPD_OIS_09182018</p> <p>Original post: Today at 3:00 pm, #GardenGrovePD Officers were dispatched a domestic violence call, where a male was attacking a female in the parking lot of the Ralph's store, at the intersection of Euclid & Chapman. Officers arrived on scene and an Officer Involved Shooting occurred. One suspect was shot and transported to a local hospital.</p> <p>The investigation will be handled by the Orange County District Attorney Tony Rackauckas shooting team and #GardenGrove Detectives. Please avoid the area for the next few hours. #GGPD32 #OIS #avoidthearea Garden Grove City Hall</p> 	12.5k	272	157	24%	3.8k
(Post) September 18, 2018 4:26 pm					

 <p>Garden Grove Police Department Last night we gained five new heroes when we swore in Officers R. Chumbe, R. Machuca, J. Melia (Golden West Academy graduates); J. Howard (Martin County Sheriff's Office lateral) and D. Rodriguez (Placentia PD lateral). Please help us welcome them into our #GardenGrovePD family. #GGPD32 #GG1956 #thinblueline #police #recruit #lateralofficer #JoinGGPD Garden Grove City Hall</p> 	3.5k	259	65	14%	554
(Post) September 19, 2018 3:01 pm					

Date Sent Total Reach Reactions Comments Engagement Clicks



Garden Grove Police Department
*****DUI/Drivers License Checkpoint Notification*****
 As part of September's Pedestrian Safety Month, there will be a **#DUICheckpoint** this Friday. For the full press release: <http://bit.ly/2NpjXIg>
#GGPD32 #GG1956 #DUI #SafeStreetsGG #duidoesntjustmeanbooze #StayAlertGG #AccidentReductionTeam
Garden Grove City Hall California Office of Traffic Safety NHTSA

9.9k 183 119 13% 1.7k



(Post) September 19, 2018 9:04 am



Garden Grove Police Department



4.3k 169 18 24% 1.4k

(Post) September 13, 2018 10:26 am



Garden Grove Police Department



4.3k 169 18 24% 1.4k

(Post) September 13, 2018 10:26 am

Date Sent Total Reach Reactions Comments Engagement Clicks



Garden Grove Police Department
 Our deepest condolences to the Costa Mesa community, **Costa Mesa Police Department**, as well as the family and friends of Officer Oscar Reyes.
#GGPD32 #thinblueline #motorofficer

4.3k 169 18 24% 1.4k

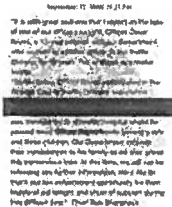

(Post) September 13, 2018 10:26 am



Garden Grove Police Department
#September is California Pedestrian Safety Month.

2.1k 28 9 12% 332

In an effort to reduce the number of pedestrians being killed and injured, **#GardenGrovePD** **#AccidentReductionTeam** conducted a citywide bicycle & pedestrian safety enforcement operation last Friday, September 14th.

The operation focused on specific locations from over the past few years where bicycle/pedestrian involved collisions have occurred. We issued a total of 52 bicyclist & pedestrian citations and 68 vehicle violations.

For the more information on this month long campaign, see <https://bit.ly/2x9ngCi>
#GGPD32 #SafeStreetsGG
#StayAlertGG #GG1956 #GardenGrove
Garden Grove City Hall NHTSA
California Office of Traffic Safety



(Post) September 17, 2018 3:00 pm

Date Sent Total Reach Reactions Comments Engagement Clicks



Garden Grove Police Department

Please help donate blood.

1.7k 13 3 3% 56

The Garden Grove Masonic Lodge #351, along with the American Red Cross, is hosting a blood drive every 2nd, 4th, and 5th Friday each month. The first one takes place tomorrow, Friday, September 14, 2:00 p.m. - 7:00 p.m., 11270 Acacia Pkwy.

For more information or to sign up, visit www.redcrossblood.org
#GGPD32 #GG1956 #GardenGrove #AmericanRedCross #masoniclodge



(Post) September 13, 2018 3:30 pm



Garden Grove Police Department

#FlashbackFriday. Fresh faces at a Police Academy Graduation (left to right: D. Thomas, J. Kolar, D. Lyons, D. Price, c. 1979)

1.4k 11 3 4% 60

: Marie Price

#GGPD32 #police #academy #policehistory #thinblueline #history



(Post) September 14, 2018 1:30 pm

Date Sent	Total Reach	Reactions	Comments	Engagement	Clicks
-----------	-------------	-----------	----------	------------	--------



Garden Grove Police Department

This is a great program, offered by the City. Please consider attending to learn more about how you can be prepared. We'll be there to talk about CERT's role with #GardenGrovePD, hope to see you as well.
#GGPD32

276	10	-	18%	50
-----	----	---	-----	----



(Post) September 15, 2018 1:15 pm

Date Sent Potential Reach Organic Impressions Responses Likes Clicks



CityGardenGrove

#September is CA Pedestrian Safety Month. In an effort to reduce the number of pedestrians being killed&injured, @GardenGrovePD's Accident Reduction Team is conducting a citywide bicycle&pedestrian operation tomorrow,7AM-3PM. #SafeStreetsGG #StayAlertGG bit.ly/2x9ngCi pic.twitter.com/5DNTIGYvvh

4.4k 716 2 636



(Tweet) September 13, 2018 2:43 pm



CityGardenGrove

West #GG Safe Routes to School Event & Bike Rodeo this Friday, September 21, 3:00 p.m. to 5:00 p.m., at Bell Intermediate, 12345 Springdale Street! #RelImagineGG #GGOpenStreets #GG1956 pic.twitter.com/xz3jXft024

2.8k 258 1 2 -

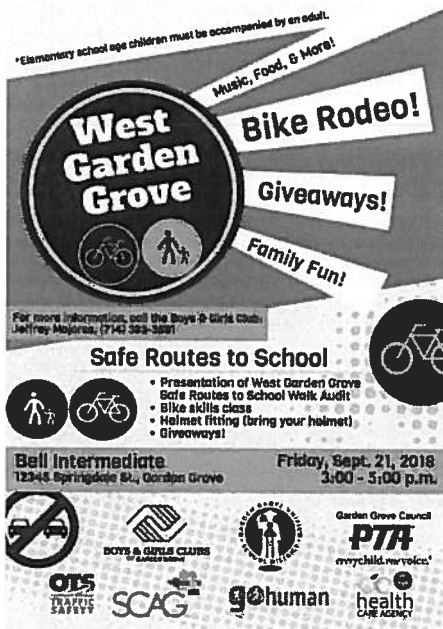

(Tweet) September 19, 2018 10:55 am

Date Sent Potential Reach Organic Impressions Responses Likes Clicks



CityGardenGrove

In celebration of **#NationalCheeseburgerDay**, several establishments known for their burgers are offering special deals to patrons. GG's own **@redrobinburgers**, at 12007 Harbor Blvd, is giving away \$5 cheeseburgers w/ the purchase of a beverage. Think **#BiGG** - Buy in **#GardenGrove!**
pic.twitter.com/eu9o6GR5IZ

2.8k 310 1 2 -



(Tweet) September 18, 2018 10:53 am



CityGardenGrove

Emergency water outage

Water Services has an emergency water outage on Stephanie, between Patricia and Geraldine, for approximately 30 minutes. Crews are going door to door to notify residents. We apologize for any inconveniences this may have caused.
#GG1956 #GG

2.9k 367 1 1 -

(Tweet) September 18, 2018 9:36 am

Date Sent Potential Reach Organic Impressions Responses Likes Clicks



CityGardenGrove

Just a friendly reminder about tomorrow's Walks with Parks -- Take a walk with @OCUnitedWay as they stroll through #GardenGrove, taking in the sights and sounds of downtown. Meet at Garden Grove City Hall, located at 11222 Acacia Parkway, at 8:00 a.m. --> [facebook.com/GardenGroveCit...](https://www.facebook.com/GardenGroveCit...) pic.twitter.com/4XcqVcoYXG

2.8k 378 - - -



(Tweet) September 14, 2018 11:11 am

WEEKLY MEMO 9-20-18

NEWS ARTICLES

Domestic violence suspect shot by Garden Grove police has died



Police in Garden Grove shot one suspect while responding to a report of a domestic dispute. (Photo by OC Hawk)

By **ERIC LICAS** | elicas@scng.com | Orange County Register

PUBLISHED: September 18, 2018 at 4:37 pm | UPDATED: September 18, 2018 at 9:56 pm

Police in Garden Grove fatally shot one suspect while responding to a report of a domestic dispute on Tuesday, Sept. 18.

Authorities received reports of a woman screaming, shouting that she could not breathe in the parking lot of the Ralph's store at 12051 Euclid St., near Chapman Avenue, according Lt. Carl Whitney, a spokesman for the Garden Grove Police Department. He said that, there, police found a 46-year-old man attacking a 43-year-old woman inside a silver Hyundai Sonata.



Garden Grove Police @GardenGrovePD · Sep 18, 2018

GGPD officers are investigating an Officer involved shooting in the parking lot of the Ralph's store at the intersection of Euclid & Chapman. One suspect was shot and transported to a local hospital. Please avoid the area. #GGPD32 #OIS

Register
Sept. 18, 2018
2 of 2



Garden Grove Police
@GardenGrovePD

Update**The initial call was a domestic violence with a male attacking a female. Officers arrived on scene and an OIS occurred. The investigation will be handled by the OCDA shooting team and GGPD Detectives. #OIS #avoidthearea #GGPD32

4:01 PM - Sep 18, 2018

17 17 people are talking about this

"The guy was strangling his wife and wouldn't stop," witness Nick Zuanich told a videographer near the site of the shooting. "The cops tried to stop him and he wouldn't stop, so they shot him."

Officers shot the man at some point after making contact with him, according to Whitney. He said the suspect was treated at the scene by officers before paramedics transferred him to a local hospital.

There he was pronounced dead at 3:38 p.m., according to a Tuesday night news release by the department. It said the woman he had been attacking was taken to another hospital with minor injuries.

Further details regarding the relationship between the man and woman or additional circumstances of the shooting were not immediately available from authorities.

Some patrons of the Ralphs supermarket had to wait hours before getting back to their cars as detectives searched a portion of the parking lot cordoned off by yellow police tape. Investigators from the Orange County District Attorney's Office and the Garden Grove Police department are looking into the incident.

Cops foil burglary, 2 men nabbed

Resident in home during break-in makes the smart play

By Brady Rhoades

Kudos to Garden Grove police for arresting two men on suspicion of a home burglary last

Editor's Take

week.

Kudos to the Orange County Sheriff's Department for providing air support during a search for the suspects.

Kudos to Chavo the crime-fighter
see FOIL, page 5

Orange Co. News
Sept. 19, 2018

FOIL:

Continued from page 1

ing canine, who sniffed out one of the men hiding behind a bush.

And kudos to the resident who was home when the burglary occurred.

We'll get back to him.

On the afternoon of Sept. 10, police were called to a burglary in progress in the 12600 block of Jetty Street in Garden Grove.

Officers arrived within three minutes, set up a perimeter around the house, and called the Orange County Sheriff's Department for air support and for, of course, Chavo.

One suspect was arrested. The other fled into the neighborhood, but Chavo sniffed him out as he hid behind shrubbery. The man, pants puddling at his ankles, was taken into custody.

Sergio Alexander Donan, 26, of Tustin, and Carlos Lopez-Gamez, 22, of Anaheim were booked at

Orange County Jail for residential burglary. Lopez-Gamez had a warrant for domestic violence.

Back to the 45-year-old homeowner.

There are a lot of tough guys — and gals — who talk about what they'd do to criminals in such a situation. Good for you if you can get it done without getting yourself or any other innocents killed.

But this man did exactly what police have told me to do when I ask about home protection.

If possible, get you and yours the heck out of the house, and call us.

In this case, the burglars broke in via the back of the

house. The homeowner hid at first, then saw his chance, booked it out the front door and called the cops.

They handled the bad guys.

That's what they're paid to do.

That's what they've trained to do.

Brady Rhoades is the editor. He can be reached at brhoades@localnewspapers.org.

There are a lot of tough guys — and gals — who talk about what they'd do to criminals in such a situation. Good for you if you can get it done without getting yourself or any other innocents killed.

Chamber scores at event



Photo courtesy Chamber of Commerce

Team "Gutterly Ridiculous" has a blast at a Garden Grove Chamber of Commerce fundraising and networking event at Bowlmor bowling alley in Anaheim last week. The team was named Best Dressed. For information about local business and upcoming events, call the chamber at 714-638-7950.

District school wins big award

La Quinta High recognized for helping students reach their dreams



Courtesy photo

La Quinta High School administrators and members of the school's counseling team celebrate winning a top award.

Garden Grove Unified School District's La Quinta High School was recognized with a top award for its exemplary work in helping students secure financial aid and achieve their goals of attending college.

La Quinta High, located in Westminster, participated in the 2018 Race to Submit statewide campaign, an initiative of the California Student Aid Commission to increase the number of students who complete the Free

Application for Federal Student Aid and the California Dream Act Application.

La Quinta High School submitted 490 applications for a submission rate of 88.45 percent and a completion rate of 84.48 percent and is ranked among the top 35 California high schools with the highest completion rates.

"This award is a testament to the outstanding counselors and guidance team at La Quinta High School for going above and beyond to provide students with hands-on support in the college application process and to help remove every obstacle to college," said Bob Harden, Board of Education president.

La Quinta High School will be recognized in Sacramento during the Race to Submit Award Ceremony on Oct. 4.

Orange Co. News
Sept. 19, 2018

Healthy food free of charge

School district expands program that feeds hungry students

The Garden Grove Unified School District has expanded its Mobile School Food Pantry program, which launched last year at Peters K-3 and Peters 4-6 elementary schools in partnership with the Second Harvest Food Bank of Orange County.

During the 2018-2019 school year, the mobile food pantry program will be offered again at Peters Elementary School, and also at Heritage Elementary Computer Science Immersion Academy and Violette Elementary School.

At the mobile food pantry, area families and community members may select free fruits and vegetables and receive nutritional information about healthy eating. The program aims to fight hunger in the community and is offered at more than 30 schools across Orange County through an application process.

"We are thrilled to see this program grow because we know how important it is to ensure students and their families have access to healthy food," said Teri Rocco, Board of Education trustee. "We encourage the community to take advantage of this free resource."

Second Harvest Food Bank provides training in operation

and food safety protocols at these farmer's market style events. Parent volunteers help run the pantry which is offered once a month at each of the three schools. Attendees must bring their own bags to carry their produce home.

The schedule for the Mobile Food Pantry at Peters Elementary School, located at 13162 Newhope St. in Garden Grove, is Oct. 5 at 1:30

p.m., Nov. 2 at 1:30 p.m., Dec. 7 at noon, Jan. 11 at 1:30 p.m., Feb. 1 at 1:30 p.m., March 1 at 1:30 p.m., April 12 at 1:30 p.m., May 3 at 1:30 p.m., and June 7 at 1:30 p.m.

The Mobile Food Pantry events at Heritage Elementary Computer Science Immersion Academy will be held at 2 p.m. on Oct. 4, Nov. 1, Nov. 29, Jan. 10, Feb. 7, March 7, March 28,



Courtesy photo

The Mobile Food Pantry is coming to Garden Grove schools.

May 2, and June 6. Heritage Elementary Computer Science Immersion Academy is at 426 S. Andres Place in Santa Ana.

The Mobile Food Pantry events at Violette Elementary School will take place at 9 a.m. on Oct. 9, Nov. 13, Dec. 4, Jan. 8, Feb. 5, March 5, April 9 and May 7. Violette Elementary School is at 12091 Lampson Ave. in Garden Grove.

‘There is a safe place to turn for help’

District expands mental health services at schools

The Garden Grove Unified School District has expanded its mental health resources to provide greater social emotional support for all students.

New in the 2018-2019 school year, the district expanded its ASPIRE social work program from five schools to 15 schools. Last year, the district contracted with one social worker and five social work interns to provide site-based mental health services for high need schools.

The program experienced such success that the district increased its number of school social workers to three and the number of interns to 10.

The district ASPIRE team will be supporting students’ well-being by providing prevention, counseling and case management services to 15 schools.

“At GGUSD, we are deeply committed to the whole child and we know that our students come to the classroom with a variety of personal issues which can often make it difficult to learn,” said Board of Education Trustee Walter Muneton. “We want all students to know there is a safe place to turn for help at school.”

see HELP, page 8

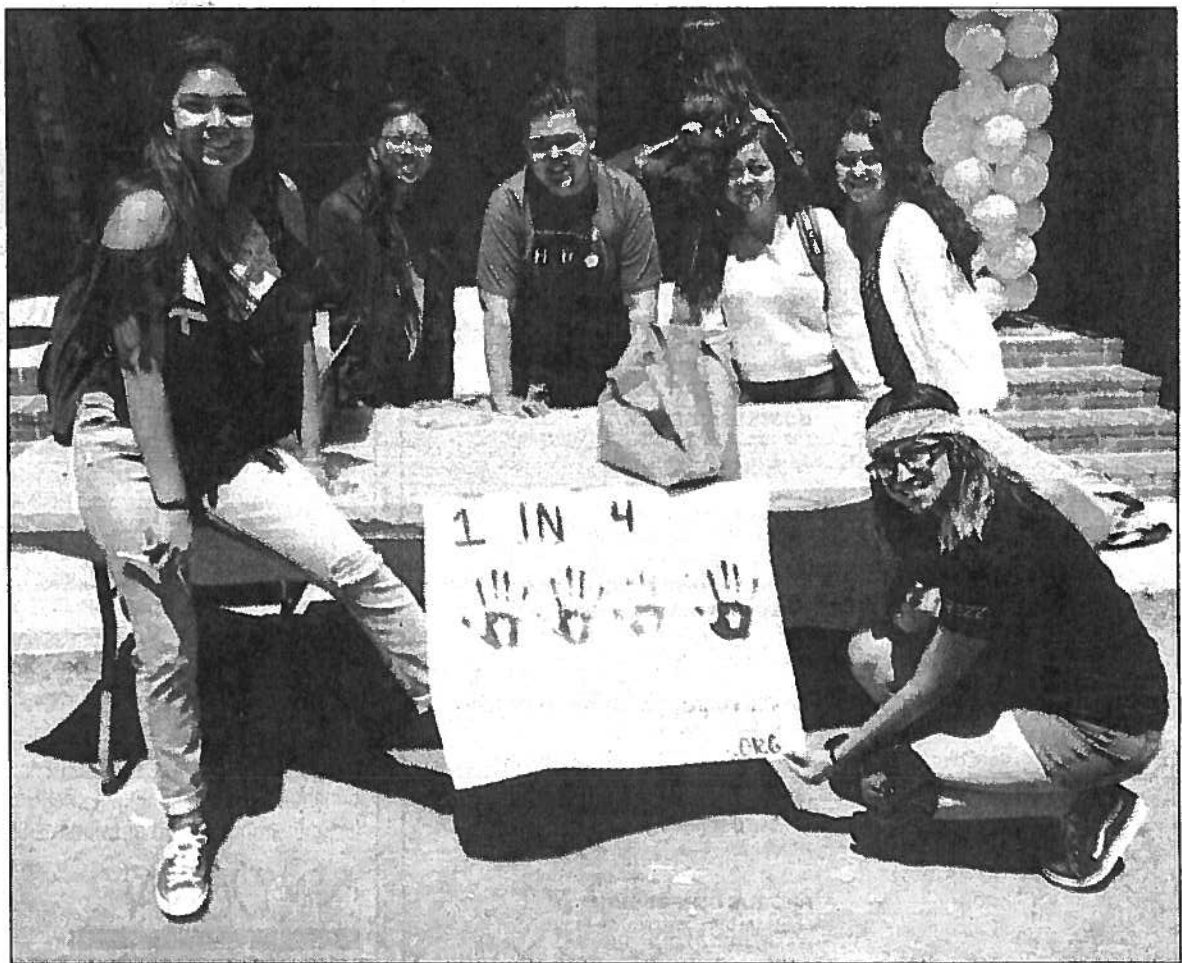

Courtesy photo

Rancho Alamitos High School has a student club dedicated to mental health awareness. Students hosted a series of events for National Mental Health Awareness Week last year.

HELP:

Continued from page 1

The social work program is one of many mental health services offered through the district's Department of Special Education and Student Services. All GGUSD schools have access to at least two to three hours of counseling per week by a credentialed GGUSD school psychologist thanks to an increase in the total number of school psychologists from 23 to 39, which provides a stronger network of mental health care for district students.

In addition, each district school has at least 10 hours of direct counseling hours that, district-wide, equate to more than 23,000 hours. These hours are provided through strong partnerships that GGUSD has with four con-

racted community-based organizations.

Over the last several years, the district has placed a targeted focus on creating positive school climates within our schools. While all schools provide a safe and supportive learning environment, 35 schools have implemented Positive Behavioral Interventions and Supports (PBIS). PBIS helps staff and students by using proactive strategies to promote positive school wide behavior.

Additionally, 14 schools implemented programs that directly teach students social-emotional skills. One such program is classroom mindfulness, which teaches students resiliency and self-regulation. Four schools also are using restorative practices through community classroom circles to build positive relationships and increase classroom engagement.

Orange Co. News
Sept. 19, 2018

Miss GG pageant

Two queens will be crowned later this month.

The 2019 Miss Garden Grove and Outstanding Teen Scholarship Pageant will be held at 6 p.m. on Sept. 29 at Hilton Bell Intermediate School, 12345 Springdale St. in Garden Grove.

The event is sponsored by the Garden Grove Chamber of Commerce. Cost to attend is \$20.

For information, call Chamber CEO/President Cindy Spindle at 714-638-7950 or email her at ceo@gardengrovechamber.com.

City of Garden Grove

Notice Inviting Sealed Bids (IFB)

Project No. S-1241

Notice is hereby given that sealed bids will be received at the office of the Purchasing Agent for the City of Garden Grove, Room 220, Second Floor, 11222 Acacia Parkway, Garden Grove, CA 92840 to Provide HP Storage Equipment per the bid specifications. A copy of the bid document may be obtained from the City of Garden Grove's website. Direct any questions regarding this bid process to Sandra Segawa via email at sandras@gg-city.org. Bids are due and will be opened in the office of the Purchasing Agent at 2:00 p.m. on Friday, October 19, 2018. Bids received after that exact time will not be considered.

Dated: September 19, 2018

Orange County News 9/19,26/2018-70371

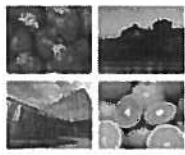

ORANGE COUNTY TRIBUNE

■ Garden Grove
■ Huntington Beach
■ Westminster
and Orange County

www.orangecountytribune.com Non-partisan news, opinion, arts and sports. Updated daily.

OPINION

Having it your way on the right-of-way

BY OC TRIBUNE STAFF ON SEPTEMBER 19, 2018 • (LEAVE A COMMENT)



BIKE PATHS and walking trails along the old P.E. right-of-way could be taking on a new dimension.

Transportation news in Orange County used to revolve mostly around what kind of car you were going to buy, and what could be done about the nightmare at The Orange Crush (now only slightly less crushy).

In a Facebook post a few days ago, Garden Grove Mayor Steve Jones took the unofficial wraps off an intriguing idea for the long-abandoned Pacific Electric right-of-way, which runs diagonally like a scar through Orange County from Buena Park to Santa Ana.

(<https://orangecountytribune.files.wordpress.com/2018/01/usually-reliable-sources-e1527735160254.jpg>) Responding to a question about more bike paths and parks, he wrote this:

“It’s already in the works ... We are planning to build out the old Pacific Electric right-of-way into a bicycle and pedestrian path with kiosk restaurants and retail along the way. We are also implementing our ‘Pedals and Feet’ master plan to better connect the city with active transportation routes.”

How cool is that? You can burn off the calories from the burger or taco you ate along the way by pedaling home.

The bike and pedestrian paths we've heard about, but the restaurants and retail are new to us. The city has received grants to take the section that runs from the downtown area northwest to Brookhurst Street and turn it into something lovely for cyclists and walkers. That's only a portion of the total route, but if the mayor's concept comes to fruition it would add a lot of parkland to the city and subtract a lot of wasted space.

A new West Side Story?

Folks in the West Grove area (that's West Garden Grove) have been concerned for a while about what they feel is a drain of retail and eating opportunities in their area, which is primarily along Valley View Street.



THE VACANT former Coco's restaurant at Valley View Street and Cerulean Avenue in West Garden Grove (Tribune photo).

approved and on the drawing boards.

“Our” OC Streetcar could be just the start ...

If you're into trying to gaze into a crystal ball to see what the future holds – as we do – one interesting place to gaze is into the Long Range Transportation Plan put forth by the Orange County Transportation Authority.

Even allowing for the reality that a lot of what's suggested is “blue sky” thinking that may never come to pass, it's still thought-provoking to see what might be coming our way.

Some of the notions presented in the executive summary of the report include:

- adding a car pool lane along portions of Pacific Coast Highway.
- adding a regular lane along the Newport (55) Freeway between the Garden Grove (22) Freeway and the Santa Ana (5) Freeway.
- adding “high quality transit” along the Harbor Boulevard Corridor between Cal State Fullerton and downtown Santa Ana.
- adding “high-quality transit” between the Goldenwest Transportation Center (near Golden West College and the Bella Terra shopping center) and UC Irvine.



Orange Co. Tribune
Sept. 19, 2018
2 of 3

There may be some good or at least interesting news coming. The Urban Land Institute held a workshop in July on what they're calling the Valley View Corridor and we are told that the report – with recommendations, we presume – should be out in mid-October.

The Tribune, of course, will be reporting on that, and the full report will be posted online when it becomes available.

An historic note: a similar report on the Harbor Boulevard corridor a decade or more ago helped kick-start the development there which is still ongoing with four more hotels



STREETCARS like this might be in the future for several areas of Orange County (OCTA image).

- adding “high-quality transit” along the Beach Corridor between the downtowns of Fullerton and Huntington Beach.
- adding “high-quality transit” along the “Main Corridor” between the Anaheim ARTIC transportation center and South Coast Plaza.

Now, there are no specifics about what “high-quality transit” would mean, but we doubt it refers to a few more buses. Putting all that together suggests to us that the OCTA might like to consider a county-wide streetcar or similar system if the OC Streetcar project connecting Santa Ana and Garden Grove (almost ready to start construction) is successful.

The summary is available on line at www.octa.net (<http://www.octa.net/>).

Usually Reliable Sources is posted on alternate Wednesdays.

**Orange Co. Tribune
Sept. 19, 2018
3 of 3**

Orange Co. Tribune
Sept. 18, 2018



www.orangecountytribune.com Non-partisan news, opinion, arts and sports. Updated daily.

GARDEN GROVE

Police fatally shoot man in market lot

BY OC TRIBUNE STAFF ON SEPTEMBER 18, 2018 • (LEAVE A COMMENT)

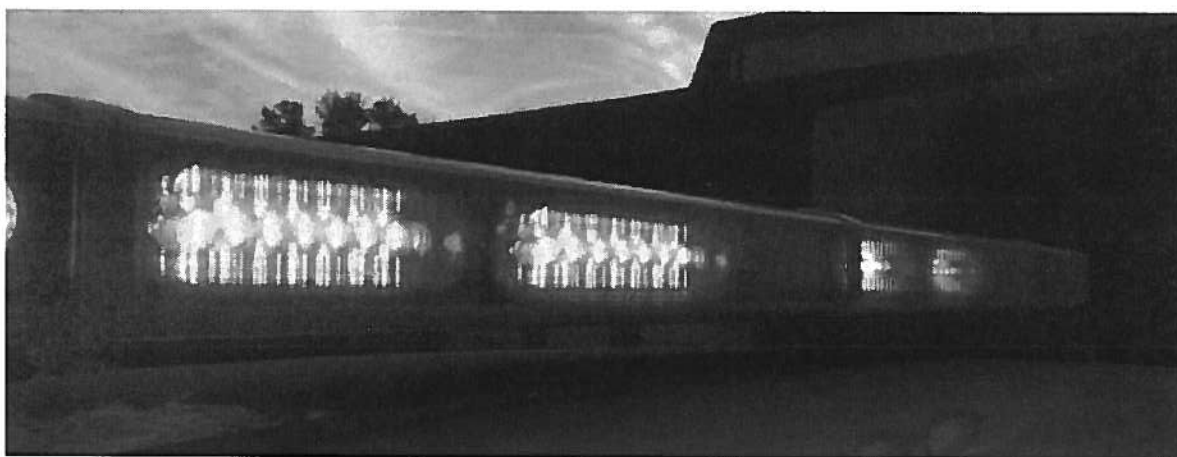

GARDEN GROVE police shot a man in a supermarket parking lot Tuesday afternoon.

A 46-year-old man is dead after being shot by a Garden Grove police officer Tuesday afternoon in a supermarket parking lot. According to Lt. Carl Whitney of the GGPD, the incident took place around 3 p.m. in the lot of the Ralph's supermarket at Euclid Street and Chapman Avenue.

Police were called in response to witnesses seeing a man attacking a woman inside a silver Hyundai Sonata; the woman begged the man to stop, saying she couldn't breathe.

An officer arrived within minutes of receiving the call and found the Hyundai near the store's east entrance doors. He confronted the man and "an officer involved shooting occurred," said Lt. Whitney.

The suspect was shot and the officer rendered first aid. The suspect – described as a transient – was transported to a local trauma center where he died of his injuries at 3:38 p.m. The woman, 43, a resident of Garden Grove, had minor injuries and was taken to another hospital for treatment. The officer was not injured.

Police believe the man and woman were known to each other. The incident is being investigated by the Orange County District Attorney's office and the GGPD. The identity of the man is being withheld pending a preliminary investigation and notification of the next of kin.

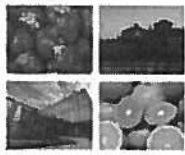

ORANGE COUNTY TRIBUNE

■ Garden Grove
■ Huntington Beach
■ Westminster
and Orange County

www.orangecountytribune.com Non-partisan news, opinion, arts and sports. Updated daily.

GARDEN GROVE

New Taco Bell coming to downtown?

BY OC TRIBUNE STAFF ON SEPTEMBER 14, 2018 • (LEAVE A COMMENT)



A TACO BELL store, not necessarily the design of the one proposed for Garden Grove's downtown (Taco Bell, Inc.)

Another fast food eatery could be coming soon to the downtown area. When the Garden Grove Planning Commission meets on Thursday, Sept. 20, it will consider site plan approval for a Taco Bell restaurant in what is now the parking lot of the Home Depot store.

Fountainhead Shrugged LLC is proposing to build a new 2,485-square foot restaurant with a drive-thru lane on the western portion of the lot facing Grove Avenue, north of Garden Grove Boulevard.

The downtown area is already home to a Del Taco, McDonald's and a Starbucks. The SteelCraft development now under construction on Euclid Street two blocks to the west will add 14 new eating and drinking spots to the city's original commercial core.

Also on the agenda is an application for a one-year time extension for the construction of a new service station with a new drive-thru convenience store on a vacant lot at 7051 Garden Grove Blvd., west of Knott Street.

Additionally, the planners will consider a general plan amendment to adopt a bicycle and pedestrian plan and to add the Garden Grove Active Streets Master Plan as an appendix.

The commission meets at 7 p.m. in the council chamber in the Community Meeting Center, 11300 Stanford Ave.

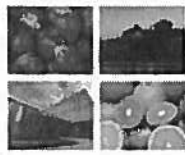

ORANGE COUNTY TRIBUNE

■ Garden Grove
■ Huntington Beach
■ Westminster
and Orange County

www.orangecountytribune.com Non-partisan news, opinion, arts and sports. Updated daily.

SCHOOLS

GGUSD expands mental health resources

BY OC TRIBUNE STAFF ON SEPTEMBER 15, 2018 • (LEAVE A COMMENT)



RANCHO Alamitos High School has a student club dedicated to mental health awareness. Students hosted a series of events for National Mental Health Awareness Week last year (GGUSD photo).

Garden Grove Unified School District has expanded its mental health resources to provide greater social emotional support for all students.

New in the 2018-2019 school year, GGUSD expanded its ASPIRE social work program from five schools to fifteen schools. Last year, GGUSD contracted with one social worker and five social work interns to provide site-based mental health services for high need schools. The program experienced such success that GGUSD increased its number of school social workers to three and the number

of interns to 10. The GGUSD ASPIRE team will be supporting students' well-being by providing prevention, counseling and case management services to 15 schools.

(<https://orangecountytribune.files.wordpress.com/2016/08/ggusdlogo.png>)The social work program is one of many mental health services offered through the district's Department of Special Education and Student Services. All GGUSD schools have access to at least two to three hours of counseling per week by a credentialed GGUSD school psychologist thanks to an increase in the total number of school psychologists from 23 to 39, which provides a stronger network of mental health care for GGUSD students. In addition, each GGUSD school has at least 10 hours of direct counseling hours that, district-wide, equate to more than 23,000 hours. These hours are provided through strong partnerships that GGUSD has with four contracted community-based organizations.



Over the last several years, GGUSD has placed a targeted focus on creating positive school climates within our schools. While all schools provide a safe and supportive learning environment, 35 schools have implemented Positive Behavioral Interventions and Supports (PBIS). PBIS helps staff and students by using proactive strategies to promote positive school wide behavior.

Additionally, 14 schools implemented programs that directly teach students social-emotional skills. One such program is classroom mindfulness, which teaches students resiliency and self-regulation. Four schools also are using restorative practices through community classroom circles to build positive relationships and increase classroom engagement.

GGUSD serves most of Garden Grove and portions of Santa Ana, Anaheim, Westminster, Cypress, Stanton, and Fountain Valley.

Orange Co. Tribune
Sept. 15, 2018
2 of 2



CITY OF GARDEN GROVE NEWS

CONTACT: Ana Pulido (714) 741-5280
PIO, Office of Community Relations/GGTV3

FOR IMMEDIATE RELEASE

Public Information Office (714) 741-5280

Follow the City of Garden Grove on Social Media

Thursday, September 20, 2018



GARDEN GROVE TOURISM GIVES BACK TO THE COMMUNITY THROUGH \$100K SPONSORSHIP

Last Tuesday, September 11, 2018, the City joined the Garden Grove Tourism Promotion Corporation (G.G.T.P.C.) for the Garden Grove Tourism Cares event. The G.G.T.P.C. awarded a total of \$100,000 to four, local, non-profit organizations with \$25,000 sponsorships each. The organizations were: Boys and Girls Clubs of Garden Grove; Garden Grove Community Foundation; Helping Others Prepare for Eternity (H.O.P.E.); and Orange County Food Bank, a division of Community Action Partnership of Orange County.

At the event, Garden Grove Mayor Steve Jones said, "Garden Grove is known for its community spirit, volunteerism, and compassion for those less fortunate. The organizations being honored tonight are dedicated community partners who commit their time and effort to improving the quality-of-life in Garden Grove."

The presentation was held at the Anaheim Marriott Suites, in the Grove District-Anaheim Resort. In attendance were local and state representatives, board members from each recognized organization, City officials, and G.G.T.P.C. members.

Jim Durslag, G.G.T.P.C. President, said, "As a valued partner to the City, the Garden Grove Tourism Promotion Corporation looks for every opportunity to give back to the community. Through sponsorships to local non-profit organizations, G.G.T.P.C. can effectively make an impact in Garden Grove."

-more-

Garden Grove Tourism Gives Back to the Community through \$100K Sponsorship
2-2-2

The G.G.T.P.C., a California non-profit mutual benefit corporation, promotes Garden Grove's tourism district, the Grove District-Anaheim Resort. In addition, G.G.T.P.C. constructs and maintains the business conditions of hotels, visitor accommodation facilities, and other services, activities, and programs that promote and encourages tourism within Garden Grove.

To learn more about the Garden Grove Tourism Promotion Corporation, please contact G.G.T.P.C. President, Jim Durslag, at (714) 539-3300.

To view photos of the Garden Grove Tourism Cares event, visit the City's Facebook at Garden Grove City Hall or search for #ggtourismcares.

For a video of the event, visit <http://bit.ly/2QFTTAB>. The video was produced by the City's award-winning Garden Grove TV3.

###



CITY OF GARDEN GROVE NEWS

CONTACT: C.E.R.T. Operations
(714)741-5040
Wednesday, September 19, 2018

FOR IMMEDIATE RELEASE

Public Information Office (714) 741-5280
Follow the City of Garden Grove on Social Media



EMERGENCY FIRST RESPONDERS TO HOLD MEET AND GREET

The City's C.E.R.T. (Community Emergency Response Team) is holding a meet and greet on Saturday, September 29, from 9:00 a.m. to 11:00 a.m., at Charlie Miller Hall, 13252 Garden Grove Boulevard.

C.E.R.T. extends a welcome to the community to learn more about the program and ways to help first responders. Members of the Garden Grove Fire and Police Departments will also be on hand.

C.E.R.T. is a group of citizens trained in basic first aid, firefighting, rescue techniques, disaster preparedness, and many other skills to help the community in the event of a major disaster.

The first 50 families that RSVP will receive a preparedness kit. Attendees will see a display of the emergency response trailer; receive a continental breakfast; and be entered into a raffle for emergency supplies.

For more information or to RSVP, please email gcert.oc@gmail.com or call (714) 741-5040.

###

MISCELLANEOUS ITEMS

September 20, 2018

1. Calendar of Events
2. Notice of Cancellation of the Zoning Administrator meeting on 9/27/2018.
3. League of California Cities, 2018 Annual Conference Report, dated 9/18/2018.
4. League of California Cities, Governor Brown Legislative Update, dated 9/19/2018.



GARDEN GROVE

CALENDAR OF EVENTS

September 20, 2018 – October 7, 2018

Thursday	September 20	7:00 p.m.	Planning Commission Meeting, Council Chamber
Friday	September 21	9:00 a.m.- 11:00 a.m.	Employee Health & Benefits Fair CMC AB Room
Tuesday	September 25	10:00 a.m.	H. Louis Lake Senior Center's Annual Spelling Bee, Senior Center Dining Room
		6:00 p.m.	Closed Session, Founders Room
		6:30 p.m.	Housing Authority Meeting, Council Chamber
		6:30 p.m.	Sanitary District Meeting, Council Chamber
		6:30 p.m.	Successor Agency Meeting, Council Chamber
		6:30 p.m.	City Council Meeting, Council Chamber
Thursday	September 27		Casual Day
		9:00 a.m.	Zoning Administrator Meeting City Hall, 3 rd Floor Training Room CANCELLED
		6:00 p.m.- 8:00 p.m.	Community Workshop (2 of 3 – Create) Vision Plan for Willowick Site Spurgeon Intermediate School 410 N. Fairview St., Santa Ana, 92703
Thursday- Sunday	September 27- September 30		One More Productions presents "The Producers" Gem Theater
Friday	September 28		City Hall Closed – Regular Friday Closure
Saturday	September 29	9:00 a.m.- 11:00 a.m.	Garden Grove C.E.R.T. Meet and Greet Charlie Miller Hall, 13252 Garden Grove Blvd.
		6:00 p.m.- 9:00 p.m.	15 th Annual Miss Garden Grove and Miss Garden Grove Outstanding Teen Pageants Bell Intermediate, 12345 Springdale Street
Thursday	October 4	7:00 p.m.	Planning Commission Meeting, Council Chamber
Thursday- Sunday	October 4- October 7		One More Productions presents "The Producers" Gem Theater



GARDEN GROVE

**NOTICE OF CANCELLATION
OF THE
GARDEN GROVE
ZONING ADMINISTRATOR
REGULAR MEETING
SEPTEMBER 27, 2018**

NOTICE IS HEREBY GIVEN that the Regular Meeting of the Garden Grove Zoning Administrator scheduled for Thursday, September 27, 2018, at 9:00 a.m. at City Hall, 11222 Acacia Parkway, Third Floor Training Room, Garden Grove, is hereby cancelled pursuant to the attached Cancellation Notice.

DATED: September 20, 2018

ALLISON WILSON
ZONING ADMINISTRATOR



GARDEN GROVE

NOTICE OF CANCELLATION

The Regular Meeting of the
Garden Grove Zoning Administrator
scheduled for September 27, 2018
has been cancelled.

**JUDITH MOORE
SECRETARY**

Zimbra

pamha@ci.garden-grove.ca.us

League of California Cities 2018 Annual Conference REPORT

From : Tony Cardenas <tcardenas@cacities.org>
Subject : League of California Cities 2018 Annual Conference
REPORT

Wed, Sep 19, 2018 11:56 AM

3 attachments

To : Tony Cardenas <tcardenas@cacities.org>



League of California Cities 2018 Annual Conference REPORT
Orange County Division Membership Elects 2019 Board of Directors

The City of Long Beach welcomed more than 1,800 city officials last week for the League of California Cities' Annual Conference & Expo. The Annual Conference featured over 40 educational sessions, 267 exhibitors and three informative general sessions.

Attendees celebrated the League's 120th Anniversary and individual city accomplishments, applauded the installation of the League's 2018-19 officers and board of directors, learned about innovative practices in California cities throughout the state, and adopted policy resolutions.

The opening general session also featured a video highlighting the League's accomplishments spanning its 120 year history and remarks from Long Beach Mayor Robert Garcia who welcomed attendees to the city.

Executive Director Carolyn Coleman delivered her State of the League address during a general session on Thursday, Sept. 13. "From advocacy in the Legislature and at the ballot box and educational programming, the League had a strong year working together with all of you to protect and expand local authority through education and advocacy to enhance the quality of life for all Californians," said Coleman.

The conference keynote speakers included leadership expert Drew Dudley, who challenged city officials with an inspiring message about everyday leadership, and political strategists Paul Mitchell, Gale Kaufman, and John Thomas, who shared their outlook and predictions on the 2018 elections. In her remarks during the closing general session, National League of Cities (NLC) First Vice President Karen Freeman-Wilson, Mayor of Gary, Indiana, underscored the value of the partnership between the League and NLC and provided an update on NLC's *Rebuild with Us* initiative, a call to action for Congress to partner with cities and invest in our vision to rebuild and reimagine America's infrastructure.

2019 League Officers and Board of Directors Elected

At its board meeting on Thursday, Sept. 13, the League board elected Grass Valley Council Member Jan Arbuckle to serve as its president, Murrieta Council Member Randon Lane to serve as first vice

president and Yountville Mayor John Dunbar as second vice president. The board also elected seven new at-large board members, which includes *Aliso Viejo Mayor Pro Tem Ross Chun* and *Tustin Council Member Allan Bernstein*.

2019 Orange County Division Board of Directors Elected

The Orange County Division General Membership voted in its 2019 Division Board of Directors on Thursday, Sept. 13. The Division President is Ed Sachs, Mayor of Mission Viejo; the Division Vice President is Gene Hernandez, Mayor of Yorba Linda; the Division Second Vice President is Stacy Berry, Mayor Pro Tem of Cypress; and the Division Director is Ross Chun, Mayor Pro Tem of Aliso Viejo.

For the full roster of the Orange County Division Board of Directors, please refer to the attached PDF.

Helen Putnam Award for Excellence

Twelve cities received the Helen Putnam Award for Excellence at the conference for their outstanding efforts to deliver services and engage residents. The award was established in 1982 and honors the League's first woman President, a dedicated public servant and Petaluma's mayor. Conference attendees enjoyed a video featuring the winning cities during the opening general session. This year's winners were:

- Enhancing Public Trust, Ethics & Community Involvement: *Garden Grove for its Neighborhood Improvement Committee Community Revitalization Initiative*.
- CCS Partnership Intergovernmental Collaboration Award: Santa Clarita for its Community Court Diversion Program.
- Community Services and Economic Development: Milpitas for its Milpitas Workforce Development Initiative.
- Economic Development through the Arts: Long Beach for its POW!WOW! Long Beach program.
- Health & Wellness Program: Davis for its Pedal for Polar Bears and Rancho Cucamonga for Healthy RC.
- Housing Programs and Innovations: Patterson for HOST House.
- Internal Administration: La Quinta for La Quinta Leadership Development.
- Planning & Environmental Quality: Porterville for its East Porterville Water Supply Project.
- Public Safety: Fontana for its Fontana Leadership Intervention Program.
- Public Works, Infrastructure & Transportation: Truckee for its Mousehole Pedestrian and Bicycle Project.
- Ruth Vreeland Award for Engaging Youth in City Government: Fresno for its Youth Commission.
- League Partners Award for Excellence in City-Business Relations: Santa Clarita for its Santa Clarita Business Incubator and Davis for its Rental Resources Program.

Annual Conference Resolutions

During the General Assembly, voting delegates approved two resolutions. More information on these resolutions is available on the League's website at www.cacities.org/resolutions. The two approved resolutions are the following:

- Calling Upon the League to Respond to the Increasing Vulnerabilities to Local Municipal Authority, Control and Revenue and Explore the Preparation of a Ballot Measure and/or Constitutional Amendment that Would Further Strengthen Local Democracy and Authority; and
- Declaring its Commitment to Support the Repeal of Preemption in California Food and Agriculture Code § 11501.1 that Prevents Local Governments from Regulating Rodenticides.

Institute for Local Government Beacon Award

The Institute for Local Government recognized eight cities with the 2018 Beacon Award. This award honors local governments that lead the way on climate, energy and sustainability through voluntary action. Each winning city is featured in 2018 Beacon Award video. This year's winning cities were:

- Redwood City (Gold);
- Santa Cruz (Gold);
- Carson (Silver);
- Long Beach (Silver);
- Mill Valley (Silver); and
- Santa Rosa (Silver).

Conference photos can be viewed on the League's Facebook page at www.facebook.com/leagueofcities. If you attended the conference and have any questions of the sessions or the materials that were provided, please email me directly.

Tony Cardenas

Public Affairs Regional Manager
Orange County Division
League of California Cities
(714) 944-4023

Tcardenas@ccities.org

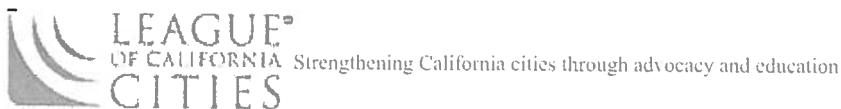

 **2019 Division Board of Directors.pdf**
132 KB



2019 ORANGE COUNTY DIVISION
BOARD OF DIRECTORS

President - Ed Sachs, Mayor, Mission Viejo

First Vice President – Gene Hernandez, Mayor Pro Tem, Yorba Linda

Second Vice President – Stacy Berry, Mayor Pro Tem, Cypress

State League Director – Ross Chun, Mayor Pro Tem, Aliso Viejo

Large City Representative – Kim Nguyen, Council Member, Garden Grove

Large City Representative – Billy O’Connell, Mayor, Huntington Beach

Large City Representative - *Vacant*

First District Representative - Steve Nagel, Council Member, Fountain Valley

Second District Representative – Shelley Hasselbrink, Council Member, Los Alamitos

Third District Representative – Allan Bernstein, Mayor, Tustin

Fourth District Representative – Rose Espinoza, Council Member, La Habra

Fifth District Representative – Joe Muller, Council Member, Dana Point

Past President - Laurie Davies, Council Member, Laguna Niguel

Zimbra**Governor Brown Issues Legislative Update**

From : Tony Cardenas <tcardenas@cacities.org>
Subject : Governor Brown Issues Legislative Update
To : Tony Cardenas <tcardenas@cacities.org>

Thu, Sep 20, 2018 10:23 AM

📎 1 attachment



FOR IMMEDIATE RELEASE:
 Wednesday, September 19, 2018

Contact: Governor's Press Office
 (916) 445-4571

Governor Brown Issues Legislative Update

SACRAMENTO – Governor Edmund G. Brown Jr. today announced that he has signed the following bills:

- AB 347 by Assemblymember Ed Chau (D-Arcadia) – Weights and measures: inspection: fees.
- AB 709 by Assemblymember Kevin McCarty (D-Sacramento) – Sacramento Regional Transit District.
- AB 865 by Assemblymember Marc Levine (D-Marin County) – Military personnel: veterans: resentencing: mitigating circumstances.
- AB 1062 by Assemblymember Marc Levine (D-Marin County) – Postsecondary education: cross-enrollment: online education at the California State University.
- AB 1092 by Assemblymember Ken Cooley (D-Rancho Cordova) – Health care service plans: vision care services: provider claims: fraud.
- AB 1423 by Assemblymember David Chiu (D-San Francisco) – Tidelands and submerged lands: City and County of San Francisco: seawall lots: affordable housing.
- AB 1436 by Assemblymember Marc Levine (D-Marin County) – Board of Behavioral Sciences: licensees: suicide prevention training.
- AB 1565 by Assemblymember Tony Thurmond (D-Richmond) – Labor-related liabilities: direct contractor.
- AB 1654 by Assemblymember Blanca Rubio (D-Baldwin Park) – Labor Code Private Attorneys General Act of 2004: construction industry.
- AB 1786 by Assemblymember Sabrina Cervantes (D-Riverside) – Community colleges: academic credit for prior military experience.
- AB 1805 by Assemblymember Jacqui Irwin (D-Thousand Oaks) – Community colleges: Student Equity and Achievement Program.
- AB 1859 by Assemblymember Ed Chau (D-Arcadia) – Customer records.
- AB 2015 by Assemblymember Eloise Gómez Reyes (D-Grand Terrace) – Pupil instruction: information about completion of applications for student financial aid.
- AB 2031 by Assemblymember Patrick O'Donnell (D-Long Beach) – Public contracts: school facility projects: bidding requirements.

- AB 2225 by Assemblymember Monique Limón (D-Goleta) – State government: storing and recording: public records.
- AB 2309 by Assemblymember Richard Bloom (D-Santa Monica) – Sale of the West Los Angeles Courthouse.
- AB 2330 by Assemblymember Frank Bigelow (R-O'Neals) – Recreational vehicle dealers: temporary branch licenses.
- AB 2334 by Assemblymember Tony Thurmond (D-Richmond) – Occupational injuries and illness: employer reporting requirements: electronic submission.
- AB 2337 by Assemblymember Mike Gipson (D-Carson) – Nonminor dependents.
- AB 2441 by Assemblymember Jim Frazier (D-Discovery Bay) – Sacramento-San Joaquin Delta: removal of abandoned commercial vessels.
- AB 2490 by Assemblymember David Chiu (D-San Francisco) – Vital records: homeless persons.
- AB 2505 by Assemblymember Miguel Santiago (D-Los Angeles) – California State University: budget oversight policies.
- AB 2516 by Assemblymember Susan Talamantes Eggman (D-Stockton) – Dams: reservoir restrictions.
- AB 2632 by Assemblymember Miguel Santiago (D-Los Angeles) – Packaging and labeling: containers: slack fill.
- AB 2634 by Assemblymember Ed Chau (D-Arcadia) – Life insurance.
- AB 2721 by Assemblymember Bill Quirk (D-Hayward) – Cannabis: testing laboratories.
- AB 2722 by Assemblymember Jose Medina (D-Riverside) – Student financial aid: California Military Department GI Bill Award Program.
- AB 2769 by Assemblymember Jim Cooper (D-Elk Grove) – Privacy: driver's license information.
- AB 2801 by Assemblymember Rudy Salas (D-Bakersfield) – Crimes: memorials: veterans and law enforcement.
- AB 2826 by Assemblymember Laura Friedman (D-Glendale) – Pupil enrollment: interdistrict attendance.
- AB 2967 by Assemblymember Sharon Quirk-Silva (D-Fullerton) – Foster care: certified record of live birth.
- AB 2989 by Assemblymember Heath Flora (R-Ripon) – Motorized scooter: use of helmet: maximum speed.
- AB 3101 by Assemblymember Wendy Carrillo (D-Los Angeles) – Community colleges.
- AB 3177 by Assemblymember Rocky Chávez (R-Oceanside) – North County Transit District: contracting.
- AB 3212 by Assemblymember Jacqui Irwin (D-Thousand Oaks) – Service member protections.
- SB 311 by Senator Richard Pan (D-Sacramento) – Commercial cannabis activity: licensed distributors.
- SB 532 by Senator Bill Dodd (D-Napa) – Emergency services: state of emergency: cyberterrorism.
- SB 790 by Senator Mike McGuire (D-Healdsburg) – Dreissenid mussel infestation prevention: grants.
- SB 961 by Senator Ben Allen (D-Santa Monica) – Enhanced infrastructure financing districts.
- SB 1071 by Senator Richard Roth (D-Riverside) – Public postsecondary education: Chancellor of the California Community Colleges: policy to award course credit for prior military education, training, and service.
- SB 1090 by Senator Bill Monning (D-Carmel) – Diablo Canyon nuclear powerplant.
- SB 1131 by Senator Robert Hertzberg (D-Los Angeles) – Electrical and gas corporations: energy efficiency: financing options: industrial and agricultural processes: custom projects.
- SB 1145 by Senator Connie Leyva (D-Chino) – Enhanced infrastructure financing districts: maintenance.
- SB 1151 by Senator Patricia Bates (R-Laguna Niguel) – Neighborhood electric vehicles: County of San Diego.
- SB 1248 by Senator Ted Gaines (R-El Dorado Hills) – California Partnership for Long-Term Care Program.
- SB 1339 by Senator Henry Stern (D-Canoga Park) – Electricity: microgrids: tariffs.
- SB 1369 by Senator Nancy Skinner (D-Berkeley) – Energy: green electrolytic hydrogen.
- SB 1423 by Senator Ed Hernandez (D-Azusa) – Medi-Cal: oral interpretation services.

- SB 1442 by Senator Scott Wiener (D-San Francisco) – Community pharmacies: staffing.
- SB 1448 by Senator Jerry Hill (D-San Mateo) – Healing arts licensees: probation status: disclosure.
- SB 1480 by Senator Jerry Hill (D-San Mateo) – Professions and vocations.
- SB 1481 by Senator Jerry Hill (D-San Mateo) – Structural pest control: certification: fumigation: penalties.

The Governor also announced that he has vetoed the following bills:

- AB 1529 by Assemblymember Tony Thurmond (D-Richmond) – Drinking water: cross-connection or backflow prevention device inspectors: certification. A veto message can be found [here](#).
- AB 1863 by Assemblymember Reggie Jones-Sawyer (D-Los Angeles) – Personal income tax: deduction: commercial cannabis activity. A veto message can be found [here](#).
- AB 2299 by Assemblymember Kansen Chu (D-San Jose) – Medi-Cal: managed care plans: informational materials. A veto message can be found [here](#).
- AB 2317 by Assemblymember Susan Talamantes Eggman (D-Stockton) – Whistleblower protection: county patients' rights advocates. A veto message can be found [here](#).
- AB 2838 by Assemblymember Evan Low (D-Campbell) – Gambling: local ordinances. A veto message can be found [here](#).
- AB 3135 by Assemblymember Jim Frazier (D-Discovery Bay) – Traffic safety: state funding. A veto message can be found [here](#).

For full text of the bills, visit: <http://leginfo.legislature.ca.gov>

###

Governor Edmund G. Brown Jr.
State Capitol Building
Sacramento, CA 95814

Tony Cardenas

Public Affairs Regional Manager
Orange County Division
League of California Cities
(714) 944-4023

Tcardenas@cacities.org

